

SIEMENS



TC Compact Series Owner's Manual

Copyright Notice

Notice

Document information is subject to change without notice by Siemens Industry, Inc. Companies, names, and various data used in examples are fictitious unless otherwise noted. No part of this document may be reproduced or transmitted in any form or by any means, electronic or mechanical, for any purpose, without the express written permission of Siemens Industry, Inc.

Warning

This equipment generates, uses, and can radiate radio frequency energy. If equipment is not installed and used in accordance with the instructions manual, it may cause interference to radio communications. Equipment has been tested and found to comply within the limits for a Class B digital device pursuant to Part 15 of the FCC rules. These limits are designed to provide reasonable protection against such interference when operated in a commercial environment. Operation of this equipment in a residential area is likely to cause interference. Residential area equipment users are required to take whatever measures necessary to correct the interference at their own expense.

Service Statement

Control devices are combined to make a system. Each control device is mechanical in nature and all mechanical components must be regularly serviced to optimize their operation. Siemens Industry, Inc. branch offices and authorized distributors offer Technical Support Programs that will ensure continuous, trouble-free system performance.

For further information, contact your nearest Siemens Solution Partner, Authorized TALON Dealer.

Copyright 2018 Siemens Industry, Inc.

FCC Regulations

The manual for an intentional or unintentional radiator shall caution the user that changes or modifications not expressly approved by the party responsible could void the user's authority to operate the equipment.

For a Class B digital device or peripheral, the instructions furnished the user shall include the following or similar statement, placed in a prominent location in the text of the manual:

NOTE: This equipment has been tested and found to comply with the limits for a Class B digital device, pursuant to part 15 of the FCC Rules. These limits are designed to provide reasonable protection against harmful interference in a residential installation. This equipment generates, uses and can radiate radio frequency energy and, if not installed and used in accordance with the instructions, may cause harmful interference to radio communications. However, there is no guarantee that interference will not occur in a particular installation. If this equipment does cause harmful interference to radio or television reception, which can be determined by turning the equipment off and on, the user is encouraged to try to correct the interference by one or more of the following measures:

- *Reorient or relocate the receiving antenna.*
- *Increase the separation between the equipment and receiver.*
- *Connect the equipment into an outlet on a circuit different from that to which the receiver is connected.*
- *Consult the dealer or an experienced radio/TV technician for help.*

To the Reader

Your feedback is important to us. If you have comments about this manual, please submit them to: SBT_technical.editor.us.sbt@siemens.com

Credits

TALON is a registered trademark of Siemens Industry, Inc.

Desigo® and Desigo® CC™ are registered trademarks of Siemens Schweiz AG.

Other product or company names mentioned herein may be the trademarks of their respective owners.

Printed in the USA.

Cyber security disclaimer

Siemens provides a portfolio of products, solutions, systems and services that includes security functions that support the secure operation of plants, systems, machines and networks. In the field of Building Technologies, this includes building automation and control, fire safety, security management as well as physical security systems.

In order to protect plants, systems, machines and networks against cyber threats, it is necessary to implement – and continuously maintain – a holistic, state-of-the-art security concept. Siemens' portfolio only forms one element of such a concept.

You are responsible for preventing unauthorized access to your plants, systems, machines and networks which should only be connected to an enterprise network or the internet if and to the extent such a connection is necessary and only when appropriate security measures (e.g. firewalls and/or network segmentation) are in place. Additionally, Siemens' guidance on appropriate security measures should be taken into account. For additional information, please contact your Siemens sales representative or visit <https://www.siemens.com/global/en/home/company/topic-areas/future-of-manufacturing/industrial-security.html>.

Siemens' portfolio undergoes continuous development to make it more secure. Siemens strongly recommends that updates are applied as soon as they are available and that the latest versions are used. Use of versions that are no longer supported, and failure to apply the latest updates may increase your exposure to cyber threats. Siemens strongly recommends to comply with security advisories on the latest security threats, patches and other related measures, published, among others, under <https://www.siemens.com/cert/en/cert-security-advisories.htm>.

Table of Contents

How to Use This Manual	9
Chapter 1—Introduction	12
TC Compact Series Product Overview.....	12
Ordering Information	13
Compatibility with the TALON Automation System	14
TCP/IP Protocol Compatibility	14
Required IP Addresses.....	14
Device Registration.....	14
Address Assignment.....	15
Principles of Field Panel Operation	16
Gathering and Processing Field Inputs	16
Executing Control Programs	16
System Program.....	17
License Manager.....	17
How does License Manager Work?	18
TALON Automation Networking	18
Management Level Network	18
Automation Level Network	18
Simultaneous ALN Access	18
How Information Moves Through the Network	19
BACnet/IP Automation Level Network.....	20
BACnet MS/TP Automation Level Network	20
Field Level Network.....	21
Chapter 2—Hardware Features	22
16- and 24-Point Compact Series Diagram.....	22
36-Point Compact Series Product Diagram	24
Supported Point Types	26
Compact Series Backup Batteries.....	28
AA Battery	28
Coin Cell Battery	29
Memory Size and Typical Battery Backup Time	30
Memory.....	30
Flash Read-Only Memory (Flash ROM).....	30
Compressed ROM	30
Auto-Restore and Database Backup to Flash	30
Auto Save	31
File System Operations	31
Random Access Memory (RAM).....	32
Communication Connections	32

HMI and Tool Ports	32
10B/100B Ethernet Port	33
RS-485 Port.....	33
USB Host Port.....	33
TX-I/O Island Bus	34
Compact Series Smoke Control Application Requirements	34
HOA (Hand-Off-Auto) Upgrade Kits	34
HOA Specifications	35
Using the HOA Switches.....	36
Default Mapping	38
PXM10S/T Product Overview and Description.....	39
Product Features.....	39
Communication Connections.....	40
Requirements	40
Application Menus	40
Operator Display Layout.....	41
Operator Display Menu Tree.....	43
Main Menu Structure.....	44
Login and Logoff.....	44
Logging In	44
Logging Off	49
Viewing, Commanding, and Releasing Points	50
Configuring Point Monitor.....	54
Configuring Settings	57
Unitary Equipment Controller	60
Unitary Equipment Controller Specifications.....	62
TX-I/O Product Range Overview	64
TX-I/O Module Overview.....	64
TX-I/O Module Product Diagram	65
TX-I/O Module LCD Symbol Chart	66
Address Keys.....	67
TX-I/O Power Supply and Bus Modules.....	68
TX-I/O Power Supply Overview	69
Bus Connection Module Overview.....	69
PX Series Enclosures and Service Boxes.....	70
PX Series Service Box Features	70
Product Numbers	72
PX Series Enclosure Specifications	73
PX Series Service Box Specifications.....	74
PX Series Enclosure Placement	74
Chapter 3—Applications	76
Operator Interface	76
Field Panel Web Server	76

Powers Process Control Language (PPCL) Control Program and Point Database	77
Control Programs	78
Point Database	78
Applications	78
Alarm Management	79
Daylight Saving Time	79
Loop/Loop Tuning	79
Trend Data Collection	79
User Access and Privileges	79
Controlling User Access to Field Panel Functions.....	80
Customized Applications	80
SNMP	80
Chapter 4—Troubleshooting	82
Service Information.....	82
Electrostatic Discharge	83
Error Status Messages.....	83
Ordering Replacement Parts.....	83
Replacing the Batteries	83
Reinstalling the Mounting Tabs.....	84
Troubleshooting Compact Field Panels	84
BATT LOW LED	84
RUN LED.....	85
Communication	86
Errors	86
Troubleshooting the TX-I/O Island Bus	86
Glossary.....	88
Index	91

How to Use This Manual

About This Manual

This manual is written for the owner and user of the TC Compact Series. It is designed to help you become familiar with the TC Compact and its applications.

This section covers manual organization, document conventions and symbols used in the manual, how to access help, related publications, and any other information that will help you use this manual.

Document Organization

This manual contains the following chapters:

- *Chapter 1—Introduction*, describes each section in this manual and presents an overview of TC Compact operation.
- *Chapter 2—Hardware Features*, describes the TC Compact hardware components and their functions.
- *Chapter 3—Applications*, describes the operating system and applications available with the TC Compact.
- *Chapter 4—Troubleshooting*, describes basic corrective measures you should take if you encounter a problem when using a TC Compact.



NOTE:

The troubleshooting section is not meant to be a full diagnostic guide, but is designed to help you address basic troubleshooting issues. If you encounter a problem not covered in this section or require further assistance, consult your Siemens Solution Partner, Authorized TALON Dealer.

- A *Glossary* describes the terms and acronyms used in this manual.
- An *Index* is provided to assist you in finding information presented in this manual.

Prerequisites

In addition to reading this owner's manual, you should also become familiar with the following technical documentation. Each document has been written to help you get the most out of your TC Compact Series hardware.

These manuals, along with information about other Siemens Industry products, technical training classes, and services can be obtained from your local Siemens Solution Partner, Authorized TALON Dealer.

- *Powers Process Control Language (PPCL) User's Manual* (588-583). This manual describes Powers Process Control Language (PPCL), the language used to write the control programs for the TC Compact.
- *TALON Firmware User's Manual* (588-580). These manuals describe the operator interface program used to communicate with TALON field panels. It contains information on defining the TC Compact database, including slopes and intercepts.

For Smoke Control Applications

Smoke Control Systems Application and Engineering Manual (125-1806). This manual is a comprehensive reference on smoke control applications for TALON equipment. It contains all of the various agency requirements and recommended practices of organizations that are widely-recognized in composing standards and testing equipment involved in life safety applications.

When Using TALON View Software

TALON View *3.x Documentation*. To view TALON View 3.x documentation, see the TALON View Online Documentation window, which you can access from the TALON View Main Menu or the TALON View program group.



Document Conventions

The following table lists conventions to help you use this manual in a quick and efficient manner.

Convention	Examples
Numbered Lists (1, 2, 3...) indicate a procedure with sequential steps.	<ol style="list-style-type: none"> 1. Turn OFF power to the field panel. 2. Turn ON power to the field panel. 3. Contact the local Siemens Solution Partner, Authorized TALON Dealer.
<p>Conditions that must be completed or met before beginning a task are designated with a ▷.</p> <p>Intermediate results (what will happen following the execution of a step), are designated with a ⇨.</p> <p>Results, which inform the user that a task was completed successfully, are designated with a ⇨.</p>	<p>▷Composer software is properly installed.</p> <p>▷A Valid license is available.</p> <ol style="list-style-type: none"> 1. Select Start > Programs > Siemens > GMS > Composer. <p>⇨The Project Management window displays.</p> <ol style="list-style-type: none"> 2. Open an existing project or create a new one. <p>⇨The project window displays.</p>
Actions that should be performed are specified in boldface font.	<p>Type F for Field panels.</p> <p>Click OK to save changes and close the dialog box.</p>
Error and system messages are displayed in Courier New font.	The message <code>Report Definition successfully renamed</code> displays in the status bar.
New terms appearing for the first time are italicized.	The field panel continuously executes a user-defined set of instructions called the <i>control program</i> .
	This symbol signifies Notes. Notes provide additional information or helpful hints.
Cross references to other information are indicated with an arrow and the page number, enclosed in brackets: [→92]	For more information on creating flowcharts, see Flowcharts [→92].
Placeholders indicate text that can vary based on your selection. Placeholders are specified in bold print, and enclosed with brackets [].	Type A C D H [username] [field panel #] .

Safety Symbols

The following table lists the safety symbols used in this manual to draw attention to important information.

Symbol	Meaning	Description
NOTICE	CAUTION	Equipment damage may occur if a procedure or instruction is not followed as specified. (For online documentation, the NOTICE displays in white with a blue background.)
	CAUTION	Minor or moderate injury may occur if a procedure or instruction is not followed as specified.
	WARNING	Personal injury or property damage may occur if a procedure or instruction is not followed as specified.
	DANGER	Electric shock, death, or severe property damage may occur if a procedure or instruction is not followed as specified.

Getting Help

For more information about TALON products, contact your local Siemens Solution Partner, Authorized TALON Dealer.

Chapter 1—Introduction

Chapter 1 provides an introduction to the TC Compact Series and how it is integrated with the TALON Automation System. The following topics are discussed:

- TC Compact Series Product Overview
- Compatibility with the TALON Automation System
 - BACnet Protocol Compatibility
 - TCP/IP Protocol Compatibility
- Principles of TC Compact Operation
 - Gathering and Processing Field Inputs
 - Executing Control Programs
 - System Program
- TALON Automation Networking
 - Management Level Network
 - Automation Level Network
 - Field Level Network

TC Compact Series Product Overview

The TC Compact Series (Programmable Controller–Compact) for BACnet networks is a high-performance Direct Digital Control (DDC) supervisory equipment controller, which is an integral part of the TALON Automation System. The controllers are classified as either a BACnet Building Controller (B-BC) with support for BACnet/IP or BACnet MS/TP protocols.

The TC Compact Series offers integrated I/O based on state-of-the-art TX-I/O™ Technology, which provides superior flexibility of point and signal types, and makes it an optimal solution for Air Handling Unit (AHU) control. The TC Compact operates stand-alone or networked to perform complex control, monitoring, and energy management functions without relying on a higher-level processor.

The TC Compact Series communicates with other field panels or workstations on a peer-to-peer Automation Level Network (ALN), or on the Field Level Network (FLN), and supports the following communication options:

- Native BACnet/IP communications over 10/100 MB Ethernet networks
- Native BACnet MS/TP on RS-485

The TC Compact is available with 16, 24, or 36 point terminations. Selected models in the Compact Series provide the following options:

- Support for FLN devices.
- An extended temperature range for the control of rooftop devices.
- Support for Island Bus, which uses TX-I/O modules to expand the number of point terminations for high-speed loop control. For TC-36 only.

Ordering Information

TC Compact Series Field Panels

Part Number	Description
TC16.2-EF32.T	TC Compact, 16 point, BACnet/IP ALN, FLN enabled
TC16.3-UCM.T	TC Unitary Equipment Controller, 16 point, BACnet MS/TP
TC16.3-UCMR.T	TC Unitary Equipment Controller, 16 point, BACnet MS/TP FLN, Rooftop Model
TC24.2-EF32.T	TC Compact, 24 point, BACnet/IP ALN or MS/TP FLN
TC24.3-UCM.T	TC Unitary Equipment Controller, 24 point, BACnet MS/TP
TC24.3-UCMR.T	TC Unitary Equipment Controller, 24 point, BACnet MS/TP FLN, Rooftop Model
TC36-E.T	TC Compact, 36 point, BACnet/IP or MS/TP ALN
TC36-EF.T	TC Compact, 36 point, BACnet/IP or MS/TP ALN includes TX-I/O and FLN support licenses

Optional Licenses

Product Number	Description
LSM-FLN.T	License to enable FLN support on models TC-16-EF.T or TC-24-EF.T
LSM-16.T	License to upgrade the UEC 16 to a TC Compact 16
LSM-24.T	License to upgrade the UEC 24 to a TC Compact 24
LSM-FLN36.T	License to enable FLN support on model TC36-E.A
LSM-IB36.T	License to enable 4 TX-I/O modules on the Island Bus on model TC36-E.T
LSM-36.T	License to enable 4 TX-I/O modules on the Island Bus and FLN support on model TC36-E.T
LSM-FPWEBPL.T	License to enable any Siemens ALN controller to supply the host controller with data for FIN Builder graphics
LSM-FPWEBPLHST.T	License to enable a TC Modular or TC-36 to host FIN Builder graphics For TC-36 only
LSM-INT-MDBS250.T	License to support Modbus 250 Driver
LSM-INT-MDBS500.T	License to support Modbus 500 Driver

TX-I/O I/O Modules

Product Number	Description
TXM1.8D	TX-I/O Module, 8 DI points
TXM1.16D	TX-I/O Module, 16 DI points
TXM1.8U	TX-I/O Module, 8 Universal points
TXM1.8U-ML	TX-I/O Module, 8 Universal points with LOID
TXM1.8X	TX-I/O Module, 8 Super Universal points
TXM1.8X-ML	TX-I/O Module, 8 Super Universal points with LOID
TXM1.6R	TX-I/O Module, 6 DO with Relay points
TXM1.6R-M	TX-I/O Module, 6 DO with Relay points with manual override

TX-I/O Power Supply and Bus Modules

Product Number	Description
TXS1.12F4	TX-I/O Power Supply, 1.2A, 4A Fuse
TXS1.EF4	TX-I/O Bus Connection Module, 4A Fuse

Accessories

Product Number	Description
TXA1.K12	One set of address keys, numbers 1-12.
TXA1.K24	One set of address keys, numbers 1-24.
TXA1.K-48	One set of address keys, numbers 25-48.
TXA1.K-72	One set of address keys, numbers 49-72.
TXA1.LLT-P100	Labels for TX-I/O, 100 sheets/pack, letter format.
TXA1.LH	Replacement label holders.

Compatibility with the TALON Automation System

TALON BACnet is compatible with the BACnet/IP protocol.



⚠ CAUTION

When working on a network with multiple firmware revisions, always connect to the operator interface at the field panel with the newest firmware revision. Otherwise, you cannot view features in newer firmware revisions, or the field panel may coldstart.

TCP/IP Protocol Compatibility

TC Compact Series controllers with BACnet/IP ALN provide the following:

- 100% compatibility with the TCP/IP protocol suite.
- Support of Dynamic Host Configuration Protocol (DHCP) and Domain Name Servers (DNS).
- Support and auto detection of 10Base-T and 100Base-TX Ethernet.

Required IP Addresses

TALON BACnet/IP ALN uses:

- One IP address per device (field panel or workstation).
- One additional shared IP address per ALN for the multicast group (when using multicast optimization).

Device Registration

Devices register with the DHCP server and Domain Name Server, if either is present.

Address Assignment

IP addresses are dynamically assigned by the DHCP server.

If an address changes or is not recognized, the field panel firmware lets you release the dynamically assigned IP address and then reconnect the field panel to the DHCP server, accepting a new IP address assignment in the process.

If there is no DHCP server at the site, you must manually assign static IP addresses as part of the startup system configuration.

Physical Addressing

Each device on the BACnet/IP ALN has a hard-wired MAC address, which is printed on the product label.

Port Numbers

The default TCP/IP port number for TALON BACnet/IP ALN communications is **5033**. You can change the TCP/IP port number if necessary.



NOTE:

All devices on the network must use the same TCP/IP port number.

You must specify a UDP port number when using multicast optimization. The default UDP port number is **8**.

Network Bandwidth

BACnet/IP ALN does not add significantly to your network overhead. Burst conditions for this product occur during:

- Database downloading after coldstart.
- Database uploading.
- Trend data uploading.
- Burst of alarms or COVs.

Data Exchange

BACnet/IP ALN sends and receives TALON data in TCP/IP packets.

BACnet/IP ALN synchronizes global data between all devices. Each device runs a global data replication engine that communicates with peer devices to:

- Exchange new and changed global data.
- Resolve conflicts when data does not match.

Device Naming Conventions

Field panel DNS node names are limited to 30 characters and cannot contain spaces.

Network Security

BACnet/IP ALN uses your intranet security within the firewall and a username/password combination to restrict access outside the firewall. You can use VLAN to improve internal security.

Principles of Field Panel Operation

The TC Compact Series gathers information about the environment of your facility, as well as the equipment it monitors and controls. The TC Compact receives updated information, stores information, executes control programs, handles operator commands and requests, and makes control management decisions. At the same time, the TC Compact also translates decisions into actions and allows the operator to observe those actions. The operator can also override and modify the decisions made by the TC Compact.

Gathering and Processing Field Inputs

The TC Compact samples the information at all field inputs, or points, approximately once each second, and stores numerical representations of the sampled values. Under certain conditions, some points require additional handling. The TC Compact initiates required actions after these points are checked against previously-entered configuration data.

Example

A log entry might be required in a point history file every 20 samples, or notification of an alarm condition could be sent to the operator as a point crossed the alarm threshold.

Executing Control Programs

The TC Compact continuously executes a user-defined set of instructions called the control program. This program uses the most recent point values and the most recent clock time. The control program does the following:

- Evaluates control strategies.
- Uses an internal calendar and time clock for time-based functions.
- Updates point values and commands field points according to the program results.
- Sends messages or reports to proper terminal locations as needed.

Example

During occupied hours (7:00 A.M. through 5:00 P.M.) a fan:

- Turns ON if the room temperature rises above 80°F (27°C).
- Turns OFF when the temperature drops below 73°F (23°C).

Between 5:00 P.M. and 7:00 A.M. the fan turns OFF regardless of the room temperature.

If the temperature rises to 85°F (29°C) at any time, the TC Compact sends an alarm message to an alarm printer.

These specifications can be met by:

1. Connecting a room temperature sensor/transmitter and fan starter output to the TC Compact.
2. Defining the room temperature sensor with a high alarm limit of 85°F (29°C) and the fan points in the TC Compact database.
3. Writing a short control program that defines your control strategy.
4. Enabling the execution for that portion of the control program.

To perform this control strategy, the TC Compact:

- Continuously executes the control program.
- Samples a current or voltage signal representing the room temperature and updates the value associated with that temperature in its memory.
 - If the temperature rises to 85°F (29°C), then the TC Compact sends an alarm message to the printer.
- Checks the current time once per second.
 - Between 5:00 P.M. and 7:00 A.M., the fan remains OFF.
 - Between 7:00 A.M. and 5:00 P.M., the control program checks the current value of the temperature and sends the appropriate ON or OFF command to the fan starter.

If the ON command is issued, the TC Compact updates the value of the starter point in its memory to reflect the current state of the fan.

System Program

The TC Compact contains a non-volatile system program called *firmware*, which can be upgraded in the field. The firmware is stored in Flash ROM memory, which keeps it virtually immune to all forms of power fluctuations or failure, including battery failure. For more information on Flash ROM memory, see Memory [→ 30].

General functionality of the firmware includes:

- Executing control programs.
- Communicating between other field panels and the workstation.
- Monitoring points.
- Managing point-related information.
- Keeping track of real time (both clock and calendar time).
- Executing self-test and error detection in the TC Compact.

License Manager

License Manager adds applications or functionality to a field panel without the need to replace the hardware or perform a firmware flash. Field panels with Firmware Revision 3.1 or later support the License Management attribute.

Contact your Siemens Solution Partner, Authorized TALON Dealer for more information on applications and functionality that can be activated through License Manager.

License Manager Definitions

- A *feature* is an application or additional functionality that can be added to a field panel without the need to replace the hardware. Some features require a firmware flash.
- A *license* is the code provided by Siemens Industry to unlock a feature.
- The *ID_STRING* is a unique identifier that distinguishes an individual piece of hardware. It is composed of the panel's part number, revision, year and week of manufacture, and serial number. Therefore, a license for one field panel will not work on another field panel.
- An *Entitlement* contains the license(s) ordered.
- An *Entitlement ID* is the SAP Purchase Order number or Reference number from the Advanced Shipping notice and your 3 character organization code.

How does License Manager Work?

Field panels can either be ordered with licensed features and functionality pre-loaded, for example, FLN support, or upgraded to add special features, for example, TX-I/O island bus support.



NOTE:

The installation of some features and licenses require that the field panel be coldstarted, while others do not.

Any or all of the licensed features can be activated at any time using licenses acquired from Siemens.

When the field panel is powered, the firmware reviews the inventory of installed features, comparing that list to the License Vault, where all installed licenses are stored. Every feature with a corresponding license is initiated and run. Because licenses are loaded into non-volatile memory, powering down the field panel will not erase them.

TALON Automation Networking

The following levels of networking provide varying levels of system integration in the TALON Automation System.

- Management Level Network (MLN)
- Automation Level Network (ALN)
- Field Level Network (FLN)

These systems also use a number of network protocols that add functionality or provide support for third-party devices.

Management Level Network

The Management Level Network (MLN) is the communications connection between individual TALON View workstations. It allows multiple TALON View users to access the entire TALON Automation System.

- An MLN is a TCP/IP Server-client network, and usually resides on the corporate LAN.
- TALON Automation Systems without a TALON View workstation do not have a Management Level Network.

Automation Level Network

The TALON Automation Level Network (ALN) provides field panel-to-field panel and TALON View workstation-to-field panel communication. The ALN types are:

- BACnet/IP ALN
- BACnet Master-Slave/Token Passing (MS/TP) ALN

Simultaneous ALN Access

More than one operator or field panel can access the network at one time. For example, as one operator accesses the system, another operator can access the system at another terminal (or from a remote site using a modem). This ensures that field panels can send alarm information to the alarm printer even as an operator accesses other information.

How Information Moves Through the Network

When an operator issues a command over the ALN network through a field panel, that field panel validates the command, determines where to send it, and then passes the command to the destination over the network.

Example

In the figure *Commanding Over an Automation Level Network*, the operator at the TALON View workstation, located in the lower level of the building, issues a command to control the main air-handling unit (AHU) of the building. This command is sent by the communication network to the field panel located on the top floor.

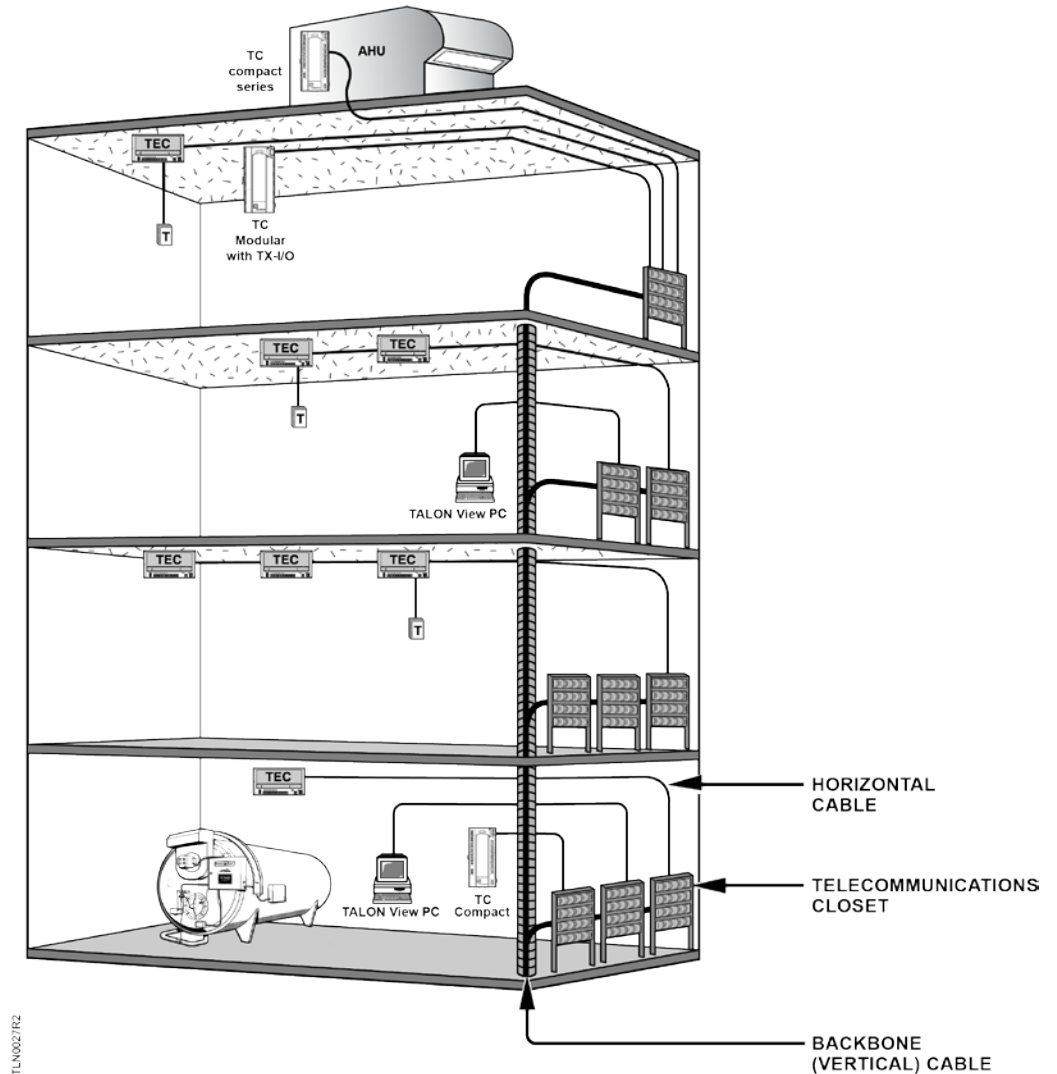

Figure 1: Figure. Commanding Over an Automation Level Network.

BACnet/IP Automation Level Network

BACnet field panels communicate over a customer's Ethernet cabling and IP network using the ASHRAE Building Automation and Control Networking (BACnet) protocol.

- One TALON View workstation can administer up to 64 Ethernet-based BACnet/IP ALNs.
- Up to 100 BACnet/IP field panels can reside on a BACnet/IP network (1000 maximum per TALON View workstation).

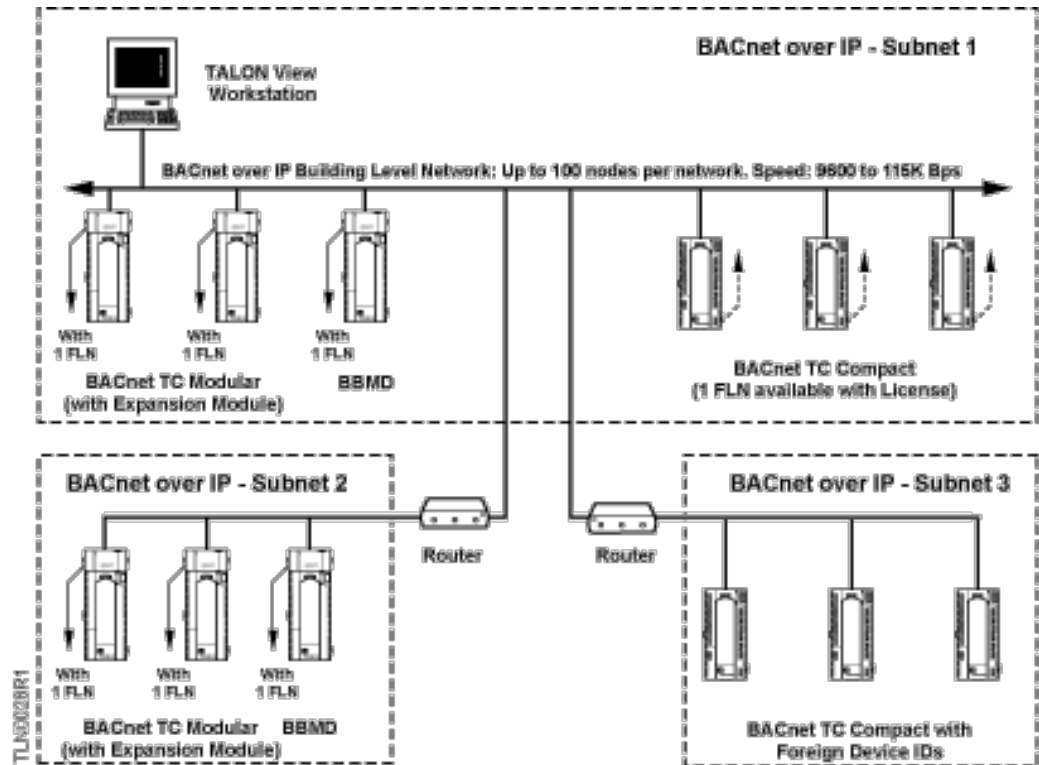

Figure 2: BACnet/IP ALN Network Example.

BACnet MS/TP Automation Level Network

BACnet field panels communicate over a customer's Ethernet cabling and IP network using the ASHRAE Building Automation and Control Networking (BACnet) MS/TP protocol.

- One TALON View workstation can administer up to 64 Ethernet based MS/TP ALNs.
- Up to 10 BACnet MS/TP ALN field panels can reside on an MS/TP network segment (1000 maximum per TALON View workstation). Network segments must be physically separated.
- BACnet devices (field panels or TALON View workstations) can be set up as one of the following:
 - A standard BACnet MS/TP device
 - A BACnet Broadcast Management Device (BBMD)
 - A foreign device

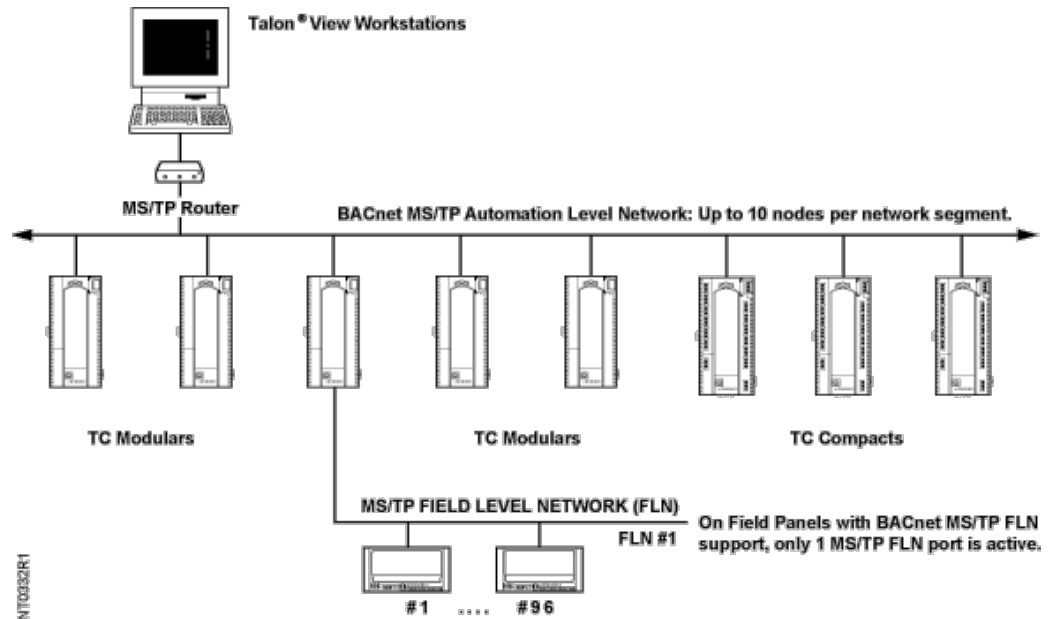

Figure 3: BACnet MS/TP ALN with MS/TP FLN Network Example.

Field Level Network

The TALON Field Level Network (FLN) is a data communications network that passes information between an FLN device or devices and an Automation Level Network (ALN) device, usually within one building. FLNs consist of devices that communicate using MS/TP.

Chapter 2—Hardware Features

Chapter 2 describes the TC Compact Series components and functions, as well as the enclosure used for the TC field panel series. The following topics are discussed:

- Product Diagrams
- Supported Point Types
- Backup Batteries
- Memory
- Communication Connections
- 24 Vdc External Sensor Power Source
- TC Compact Series Specifications
- HOA (Hand-Off-Auto) Upgrade Kits
- Compact Series Smoke Control Application Requirements
- TX-I/O Product Range
- PX Series Enclosures and Service Boxes

16- and 24-Point Compact Series Diagram

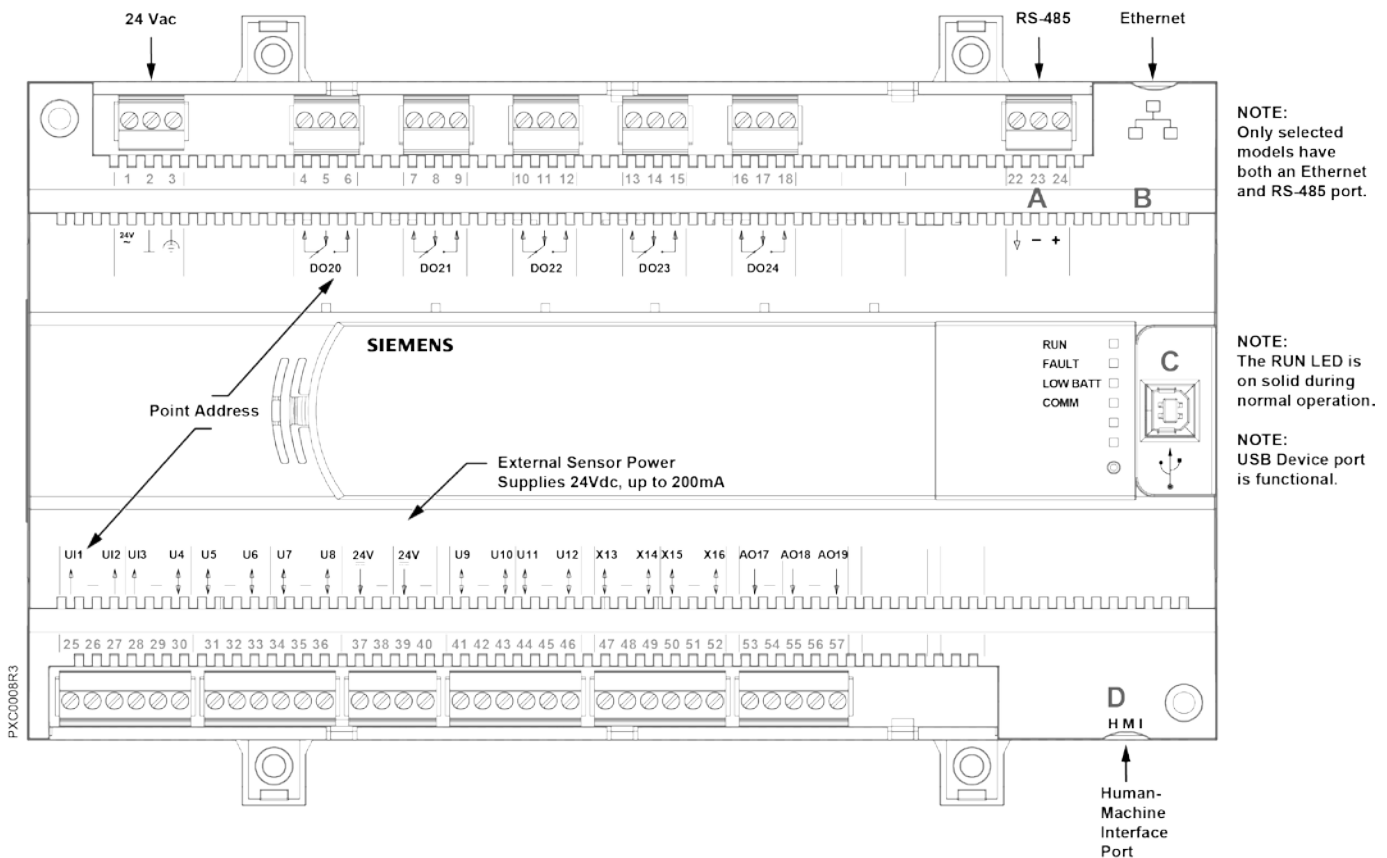

TC-16 and TC-24 Features and Symbols.		
Terminal Block Connection	Label	Indicates
1	24V ~	Supply voltage, 24 Vac input.
2	⏚	System neutral.
3	⏚	Functional earth.
4 through 12 (TC-16) 4 through 18 (TC-24)	↕↕	Digital Output relay.
A (22 through 24)	+ - ⏚	RS-485 port.
B	⏚	10B/100B Ethernet port.
C	⏚	USB Device port.
25, 27, 28	↑	Universal Input (+) (UI1 through UI3).
26, 29	-	Signal Common.
30, 31, 33, 34, 36	⏚	Universal Input/Output (+) (U4 through U8).
37, 39	24V ↓	24 Vdc external sensor power (+) source.
38, 40	-	Signal Common.
41, 43, 44, 46	⏚	Universal Input/Output (+) TC-24 only (U9 through U12).
42, 45	-	Signal Common (TC-24 only).
47, 49, 50, 52	⏚	Super Universal Input/Output (+) TC-24 only (X13 through X16).
48, 51	-	Signal Common.
53, 55, 57	↓	Analog Output (+) (TC-16: AO9 through AO11; TC-24: AO17 through AO19).
54, 56	-	Signal Common.
58, 60	↑	Digital Input (+)TC-16 only (DI12 through DI13).
59	-	Signal Common (TC-16 only).
D	HMI	Human-Machine Interface port

TC-16 and TC-24 Status LEDs.		
Status LED	Label	Indicates
RUN LED	RUN (green)	ON - Normal steady Green, unit is powered and running.
		OFF - Error.
FAULT LED	FAULT (red) (for future use)	Normal Off, not currently implemented. May be Red if processor does not complete boot.
LOW BATT LED	LOW BATT (red)	ON - Error.
		OFF - Normal operation.
Ethernet COMM LED	COMM (yellow)	ON – Linked to Ethernet network.
		Flashing indicates communicating with Ethernet network.
		OFF - No link to Ethernet network.
RS-485 TX	RS-485 TX (yellow)	Flashing - Transmitting information over the RS-485 BACnet MS/TP ALN or MS/TP FLN (depending on how the port is defined).





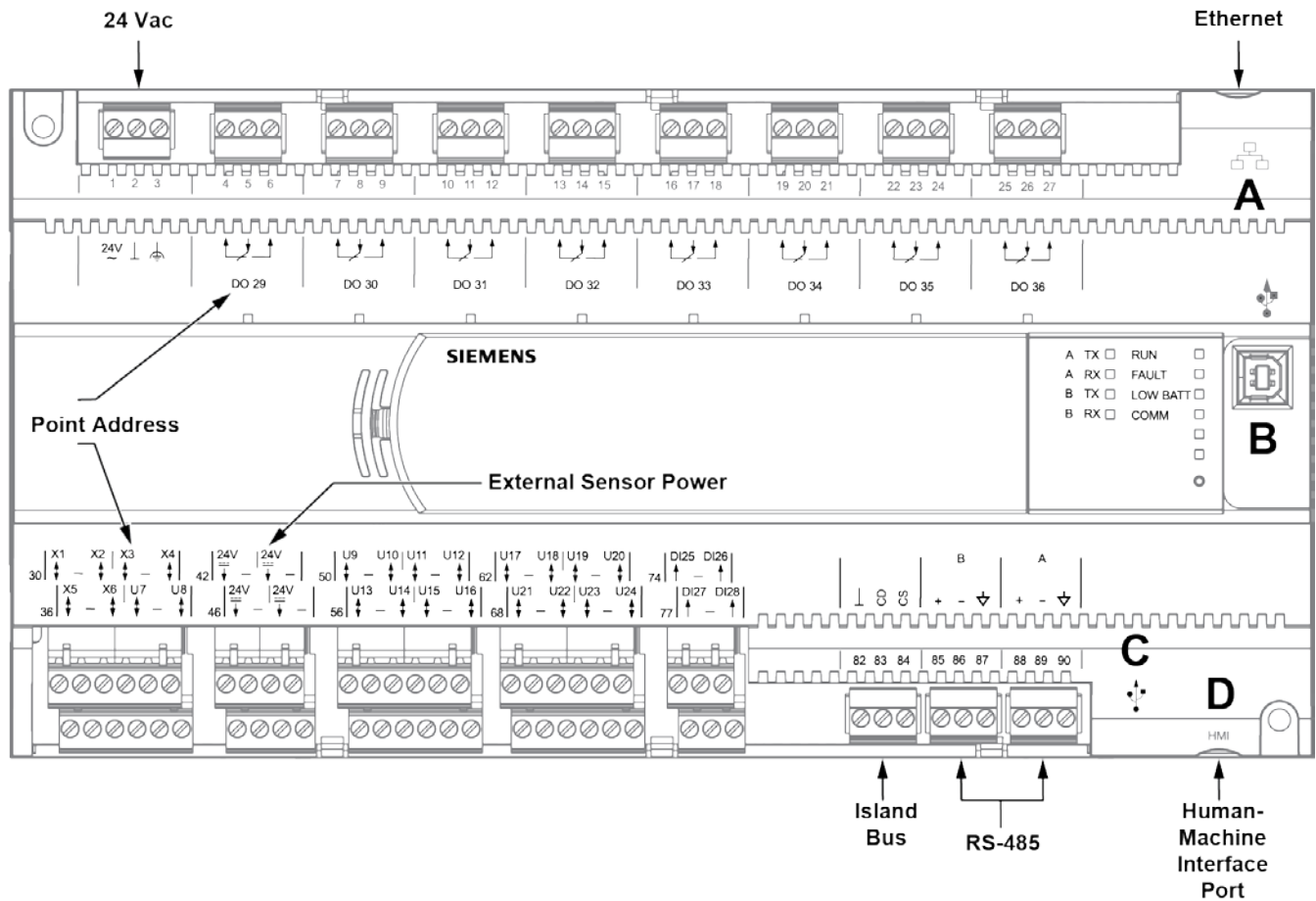



TC-16 and TC-24 Status LEDs.		
Status LED	Label	Indicates
		OFF or ON solid - No device, no connection, or bad connection.
RS-485 RX	RS-485 RX (yellow)	Flashing - Receiving information over the RS-485 BACnet MS/TP ALN or MS/TP FLN (depending on how the port is defined).
		OFF or ON solid - No device, no connection, or bad connection.
TC-16: DO 14 through DO 16; TC-24: DO 20 through DO 24	DO XX	ON – Relay Energized.

36-Point Compact Series Product Diagram



PXC0113R1

TC-36 Features, Symbols, and Status LEDs.		
Terminal Block Connection	Label	Indicates
1	24V ~	Supply voltage, 24 Vac input.
2	⊥	System neutral.
3	⊥ ⊕	Functional earth.
4 through 27	⤴ ⤵	Digital Output relay.

TC-36 Features, Symbols, and Status LEDs.		
Terminal Block Connection	Label	Indicates
A		10B/100B Ethernet port.
B		USB Device port.
30, 32, 33, 35, 36, 38		Super Universal (+). (X1 through X6)
31, 34, 37	–	Signal Common.
39, 41, 50, 52, 53, 55, 56, 58, 59, 61, 62, 64, 65, 67, 68, 70, 71, 73		Universal Input/Output (+). (U7 through U24)
40, 51, 54, 57, 60, 63, 66, 69, 72	–	Signal Common.
42, 44, 46, 48		24 Vdc external sensor power (+) source.
43, 45, 47, 49	–	Signal Common.
74, 76, 77, 79		Digital Input (+). (DI25 through DI28)
75, 78	–	Signal Common
82 through 84		Island Bus Communication
85 through 87 and 88 through 90	+ – 	RS-485 port.
C		USB Host port
D	HMI	Human-Machine Interface port

TC-36 Features, Symbols, and Status LEDs.		
Status LEDs	Label	Indicates
RUN LED	RUN (green)	ON - Normal steady Green, unit is powered and running.
		OFF - Error.
FAULT LED	FAULT (red) (for future use)	Normal Off, not currently implemented. May be Red if processor does not complete boot.
LOW BATT LED	LOW BATT (red)	ON - Error.
		OFF - Normal operation.
COMM LED	COMM (yellow)	ON – Linked to Ethernet network.
		OFF - No link to Ethernet network.
		Flashing indicates communicating with Ethernet network.
RS-485 TX	A TX (yellow)	Flashing - Transmitting information over MS/TP FLN.
	B TX (yellow)	Flashing - Transmitting information over BACnet MS/TP ALN (depending on how the port is defined).
	A TX or B TX	OFF or ON solid - No device, no connection, or bad connection.
RS-485 RX	A RX (yellow)	Flashing - Receiving information over MS/TP FLN.
	B RX (yellow)	Flashing - Receiving information over BACnet MS/TP ALN (depending on how the port is defined).
	A RX or B RX	OFF or ON solid - No device, no connection, or bad connection.
DO 29 through DO 36	DO XX	ON - Relay Energized.

Supported Point Types

The TC Compact Series provides software-configurable and dedicated points. The point types and their possible configurations are shown in the following tables.

TC-16 Supported Point Types.						
Point Type		Configurable Points			Dedicated Points	
		Universal Input (UI) Points 1-3	Universal Input/Output (U) Points 4-8	Analog Output (AO) Points 9-11	Digital Input (DI) Points 12-13	Digital Output (DO) Points 14-16
Analog Input ⁴⁾	Voltage 0 to 10 Vdc	•	•			
	Current 4 to 20 mA	•	•			
	RTD Pt 1K ¹⁾	•	•			
	RTD Ni 1K ²⁾	•	•			
	Thermistor 10K NTC ³⁾	•	•			
	Thermistor 100K NTC ³⁾	•	•			
Digital Input	Status (Binary Input)	•	•		•	
	Pulse Accumulator (Counter)	•	•			
Analog Output	Voltage 0 to 10 Vdc		•	•		
Digital Output	Binary/Digital Output					•

1) Platinum 1K 375 or 385 alpha.

2) Siemens, Johnson Controls, and DIN Standard Nickel.

3) 10K and 100K Type 2 and 10K Type 3.

4) Sensor supply 24 Vdc, 4.8W

TC-24 Supported Point Types.						
Point Type		Configurable Points			Dedicated Points	
		Universal Input (UI) Points 1-3	Universal Input/Output (U) Points 4-12	Super Universal (X) Points 13-16	Analog Output (AO) Points 17-19	Digital Output (DO) Points 20-24
Analog Input ⁵⁾	Voltage 0 to 10 Vdc	•	•	•		
	Current 4 to 20 mA	•	•	•		
	RTD Pt 1K ¹⁾	•	•	•		
	RTD Ni 1K ²⁾	•	•	•		
	Thermistor 10K NTC ³⁾	•	•	•		
	Thermistor 100K NTC ³⁾	•	•	•		
Digital Input	Status (Binary Input)	•	•	•		
	Pulse Accumulator (Counter)	•	•	•		

TC-24 Supported Point Types.						
Point Type		Configurable Points			Dedicated Points	
		Universal Input (UI) Points 1-3	Universal Input/Output (U) Points 4-12	Super Universal (X) Points 13-16	Analog Output (AO) Points 17-19	Digital Output (DO) Points 20-24
Analog Output	Voltage 0 to 10 Vdc		•	•	•	
	Current 0 to 20 mA			•		
Digital Output	Binary/Digital Output			• ⁴⁾		•



- 1) Platinum 1K 375 or 385 alpha.
- 2) Siemens, Johnson Controls, and DIN Standard Nickel.
- 3) 10K and 100K Type 2 and 10K Type 3.
- 4) Requires an external relay.
- 5) Sensor supply 24 Vdc, 4.8W

TC-36 Supported Point Types.					
Point Type		Configurable Points		Dedicated Points	
		Super Universal (X) Points 1-6	Universal Input/Output (U) Points 7-24	Digital Input (DI) Points 25-28	Digital Output (DO) Points 29-36
Analog Input ⁵⁾	Voltage 0 to 10 Vdc	•	•		
	Current 4 to 20 mA	•	•		
	RTD Pt 1K ¹⁾	•	•		
	RTD Ni 1K ²⁾	•	•		
	Thermistor 10K NTC ³⁾	•	•		
	Thermistor 100K NTC ³⁾	•	•		
Digital Input	Status (Binary Input)	•	•	•	
	Pulse Accumulator (Counter)	•	•		
Analog Output	Voltage 0 to 10 Vdc	•	•		
	Current 0 to 20 mA	•			
Digital Output	Binary/Digital Output	• ⁴⁾			•



- 1) Platinum 1K 375 or 385 alpha.
- 2) Siemens, Johnson Controls, and DIN Standard Nickel.
- 3) 10K and 100K Type 2 and 10K Type 3.
- 4) Requires an external relay.
- 5) Sensor supply 24 Vdc, 4.8W

Compact Series Backup Batteries

The TC Compact Series contains one non-rechargeable AA (LR6) battery and one non-rechargeable coin cell (BR2032) battery that serve as a power backup in the event of a power failure. The batteries only discharge during a power loss. They do not recharge.

	 CAUTION
	<p>Only use a 3.6 Volt lithium battery in TC Compact models with extended temperature range operation.</p> <p>Only use a 1.5 Volt alkaline battery in standard TC Compact models.</p> <ul style="list-style-type: none"> • The 3.6 Volt lithium battery is designed to operate at both high and low temperature extremes, and it provides a long service life in an extended temperature environment. • The 1.5 Volt alkaline battery is not guaranteed to provide backup protection in models with extended temperature range operation, even if the controller is operating in a room-temperature environment. • If a 3.6 Volt lithium battery is used in standard TC Compact models, the battery quickly discharges and provides much less backup protection than a 1.5 Volt alkaline battery.

AA Battery

	 CAUTION
	<p>Batteries</p> <p>Failure to change DEAD alkaline battery will eventually result in battery leakage, causing permanent damage and loss of building control.</p> <p>Failure to change a DEAD lithium battery will result in loss of trend and database if not backed up, causing loss of data or building control.</p> <p>Establish a preventative maintenance schedule based on expected battery usage and life cycle.</p>



- The AA battery maintains databases and volatile data, such as Trend, in RAM when power to the controller is off.
- If reserve power in the AA battery is low, the battery status is reported as **LOW** or **DEAD** and the red LOW BATT LED on the field panel is lit. When this occurs, replace the battery; do not wait until it goes dead.
- Using PPCL and the **\$BATT** point, the TC Compact can be programmed to signal an alarm printer and an operator terminal with a battery replacement message.

For more information, see the TALON Powers Process Control Language (PPCL) User's Manual (588-583).

Using Auto Restore and Database Backup to Flash

- RAM is cleared if the AA battery is dead, disabled, or missing when power to the field panel is off. In this case, if Auto Restore and Database Backup to Flash have been enabled, the database reloads in RAM when power returns; however, Trend data is lost.
- If a power failure lasts longer than the protection offered by the battery, and Auto Restore and Database Backup to Flash are not enabled, the information stored in RAM must be either reloaded from a TALON View workstation, Datamate Base or Datamate Advanced, or entered again by an operator.

Coin Cell Battery

	 CAUTION
	<p>Batteries</p> <p>Failure to change a DEAD lithium coin cell battery will result in loss of current time-date, which may cause loss of data or building control.</p> <p>Establish a preventative maintenance schedule based on expected battery usage and life cycle.</p>

- The coin cell battery maintains the current time-date in the Real Time Clock (RTC) when power to the field panel is off.
- There is no physical status on the field panel for a dead coin cell battery.
- If the coin cell battery is dead or missing when power is off, then RTC time-date is reset as follows:
 - If the field panel resides on an ALN with a TALON View workstation, the TALON View workstation sets the time-date when the field panel returns to the network.
 - If the field panel resides on an ALN without a TALON View workstation, the time-date is synchronized with the network time during the next automatic daily time update.

For more information on time synchronization, see the TALON Firmware User's Manual (588-580) (588-580).

Memory Size and Typical Battery Backup Time

Memory Size and Typical Battery Backup Time.				
Compact Model	RAM	Flash ROM	Total Memory	Typical Battery Backup RAM and Real Time Clock Data ¹
TC-16 and TC-24	16 MB	8 MB	24 MB	Non-rooftop models: 180 days (accumulated) Rooftop models: 330 days (accumulated)
TC-16 and TC-24 "F" and "F32"	32 MB	8 MB	40 MB	Non-rooftop models (accumulated): 110 days (accumulated) Rooftop models (accumulated): 200 days (accumulated)
TC-36	64 MB	16 MB	80 MB	60 days (accumulated)

¹⁾ Installing a coin cell battery provides up to 10 years backup power of the Real Time Clock for non-rooftop applications, and 18 months backup power for rooftop applications. These are typical accumulated times while power is off.

Memory

The TALON firmware (program), its point database, PPCL program, trend data, and other information reside in the field panel memory. Memory consists of two areas: Flash Read-Only Memory (Flash ROM) and Random Access Memory (RAM).

Flash Read-Only Memory (Flash ROM)

Flash Read-Only Memory (Flash ROM) is the non-volatile, permanent memory of the TC Compact, which stores the operating system, the TALON firmware, and the language files. A limited amount of secondary storage is provided in Electrically Erasable Programmable Read-Only Memory (EEPROM) for the field panel address or name, communication speeds, and other set-up parameters. In the event of a power surge, a power loss, or failure of the battery backup, the Flash ROM and EEPROM contents stay intact.

TC Compact Flash ROM size cannot be upgraded in the field.

Compressed ROM

The TC Compact has a large amount of high performance RAM. To allow for future features and to provide high system performance, the TALON firmware is stored in ROM in a compressed state; it is de-compressed into RAM on system power-up. As a result, the entire onboard RAM is not available for the point database, the PPCL program, and trend data.

Auto-Restore and Database Backup to Flash

TALON Firmware Revision 3.1 and later supports Auto-Restore and Database Backup to Flash.

- Database Backup to Flash allows the user to manually save a copy of the database in flash memory of the controller.
- The field panel may be configured to automatically restore the database from flash memory after a coldstart.

- When auto-restore is enabled, a coldstart does not result in the same downtime as with earlier revisions of TALON firmware. Because there is no waiting on a full download from the backup system, the database is restored from flash so quickly that there is little to no downtime. However, the accumulated trend data is deleted from memory.
- Database restoration from flash is disabled by default.
- When FLN Mode is selected for the PXC Compact or UEC, database restoration from flash is automatically enabled.
- The field panel may be configured to automatically restore the database from flash memory after a coldstart.
 - When auto-restore is enabled, a coldstart does not result in the same downtime as with earlier revisions of TALON firmware. Because there is no waiting on a full download from the backup system, the database is restored from flash so quickly that there is little to no downtime. However, the accumulated trend data is deleted from memory.
 - Database restoration from flash is disabled by default.

For procedures on using Auto-Restore and Database Backup to Flash, see the TALON Firmware User's Manual (588-580).

Auto Save

This feature allows the database to be backed up automatically whenever database is changed, instead of being an operator selected function. It does not provide any safeguard and or protection against power loss while the process is underway. However, this feature sends messages to HMI that the auto save operation is in progress or finished.

The feature may be turned on or off using a prompt similar to the existing Autorestore prompt. See the TALON Firmware User's Manual (588-580) for more information.

File System Operations

File System Operations provide many features and works on three drives of a field panel.

The following is a list of supported features:

- List Drives — list the drives on the field panel where **A:** is the RAM drive, **B:** is the USB drive if attached, and **IFD:** is the internal Flash Drive.
- Set_drive — identifies the drive that you want to perform other functions on.
- listDirectory — lists the files and folders contained on the selected drive.
- Change_dir — changes the current directory to allow you to view the contents of subfolders on the drive.
- File_ops — opens up the file control menu which allows you to copy, rename, delete and move files in the panel. These functions work on the drive that was selected by the Set_drive function.
- File_ops/Copy_file — allows you to copy files within a drive or to another drive.
- File_ops/Rename_file — allows you to rename a file.
- File_ops/Move_file — allows you to move a file within a drive or to another drive.
- File_ops/Delete_file — allows you to delete a file.

USB Media Support

- Support for USB mass storage devices (Memory sticks or USB hard drives).
- Backup of database, storage for graphics, Web Server upgrades

Random Access Memory (RAM)

Synchronous Dynamic Random Access Memory (SDRAM) is the working memory of the TC Compact. When the TC Compact has booted and is operating normally, the TALON firmware, the PPCL control program, the point database, and trend data have been transferred from Flash ROM. Information stored in RAM, such as the point database or PPCL, may be viewed, modified, deleted, activated, or deactivated from an operator terminal by any high-level authorized user. In the event of a power loss, the contents of RAM are kept intact by a backup battery.

TC Compact RAM size cannot be upgraded in the field.

The program length, number of database points, and number of trend entries is limited only by available memory.

Communication Connections

The TC Compact Series provides the following communication connections:

- HMI and Tool ports
- 10B/100B Ethernet port
- RS-485 port
- USB Host Port
- TX-I/O Island Bus (TC-36 only)



NOTE:

In BACnet/IP ALN mode, RS-485 parameters are displayed and may be entered as a selection. However, when in RS-485 ALN mode, BACnet/IP ALN parameters are not an available selection.

HMI and Tool Ports

- The HMI port provides a connection to a laptop computer for local operation and engineering.
- The USB Device port supports a generic serial interface for an HMI or Tool connection.

Human-Machine Interface (HMI)/Tool Port

The Human-Machine Interface (HMI)/Tool port provides RS-232 compliant communications through a quick-connect RJ-45 jack. The HMI port supports the following functionality:

- Connecting a machine interface device, such as an operator terminal or a text-based operator terminal, to the TC Compact.
- Executing firmware flash upgrades.
- 1200 bps to 115.2 Kbps communication is supported.



NOTE:

The communication speed of the port must match the communication speed of the device connected to it.

USB Device Port

The USB Device port supports a generic serial interface for an HMI or Tool device. The USB Device port does not support firmware flash upgrades.

10B/100B Ethernet Port

The 10B/100B Ethernet port provides a path for commands and information transmitted between field panels inside a firewall. This port provides both full- and half-duplex 10Base-T or 100Base-TX compliant communications over a BACnet/IP Automation Level Network (ALN). The highest possible communication speed is automatically detected and selected.

RS-485 Port

The RS-485 port provides a path for commands and information transmitted between field panels. This port provides communications over a BACnet MS/TP Automation Level Network (ALN) or MS/TP Field Level Network (FLN). The communication speed is set during startup.

The RS-485 port provides half-duplex, asynchronous serial RS-485 communications over shielded twisted pair cable. The RS-485 connector is labeled + – Ⓡ to indicate the positive and negative connections; Ⓡ is a reference pin.

- The TC-36 provides two RS-485 ports, which are labeled “A” and “B”.
- All TC-36 models and the TC-16 and TC-24 "F" models support MS/TP FLN devices on the RS-485 port.
- BACnet MS/TP routed FLN is supported for Programmable TECs (PTECs), Unitary Equipment Controllers (UECs), and third-party BACnet devices.
 - FIN Builder supports MS/TP routed FLNs and IP FLNs.
 - PPCL and Point Editing are currently not available on routed FLNs.

TC-36 RS-485 A and B Ports

The following table outlines the configuration options for the TC-36 RS-485 “A” and “B” ports.

ALN Protocol	RS-485 A Port (FLN 1)	RS-485 B Port (FLN 2)
BACnet/IP	MS/TP FLN	Not available
BACnet MS/TP	MS/TP FLN	Configured for MS/TP ALN

USB Host Port

The USB host port supports a USB printer and connection to a modem through a USB-to-RS-232 adapter. A USB hub may be used to support both a printer and modem on the USB host port.

- On a BACnet/IP ALN, the USB Host port provides support for service modems and line printers.

TX-I/O Island Bus

The TC-36 offers the flexibility of expanding the total point count through a self-forming island bus. With the addition of TX-I/O modules and a TX-I/O Power Supply, up to 16 points (or four TX-I/O modules) can be supported.

An additional license may be required to enable the Island Bus.

Compact Series Smoke Control Application Requirements



⚠ CAUTION

The 115V or 230V PX Series Service Box is required for UL864 and NFPA92A compliant installations. For more information, see the *PX Series Service Box Assemblies Installation Instructions* (553-131) or the *Service Box Installation Instructions* (586-135). For non-UL864 and non-NFPA92A applications, any 24 Vac Class 2 transformer can be used.



NOTE:

For smoke control applications over BACnet/IP, the field panel must be connected to the Automation Level Network (ALN) through an Ethernet switch that is UL Listed for Fire Signaling. ALN and FLN circuits are supervised.

For smoke control applications, mount the TC Compact inside a 19-inch or 34-inch PX Series enclosure (PXA-ENC19 or PXA-ENC34). For more information, see the *19" and 34" PX Series Enclosure Assemblies Installation Instructions* (553-130).

Service Modem Kit (538-915) is required for remote connection to the HMI of a TC Compact running smoke control applications. The modem, serial cable, and surge suppressor must be installed inside the 19-inch or 34-inch PX Series enclosure with a Service Box.

For modems used with smoke control applications:

Modem Requirements

- The UL864 Listed surge protector (538-600) is required.
- Devices connected between the USB port and the UL Listed surge protector must be located within the same room.
- A USB-to-RS-232 adaptor may be needed for UL Listed modems or UL Listed printers that are not configured for USB communication.
- The modem may be located inside the PX Series enclosure.

HOA (Hand-Off-Auto) Upgrade Kits

HOA Upgrade Kits are available for TC Compact Series field panels. HOA Upgrade Kits are not compatible with Unitary Equipment Controllers (UEC 16 or UEC 24). The upgrade kits replace TC Compact covers with new covers equipped with manual override switches and LEDs for visual feedback at the field panel.

Users can override the default switch assignment or customize the switches to their desired configuration.

- The HOA module can be used to override outputs and monitor inputs.
- The HOA mapping and definition of a logical point in the database can be done in any order.
- The HOA is hot-swappable. The module can be installed without powering down the controller and interrupting facility operations.
- The HOA module can also be remote mounted on the inside or outside of an enclosure door, using an optional accessory sold separately.

HOA Specifications

Electrical

Power Consumption 5 V/60 mA
(from host controller)

Baud rate 38400

Dimensions (L x W x D) 5.65 in. × 1.8 in. × 0.68 in.
(14.4 cm × 4.6 cm × 1.7 cm)

Weight

8 Switch 0.12 lb

16 Switch 0.14 lb

Operating Environment

Ambient Operating Temperature 23°F to 122°F (-5°C to 50°C)

Ambient Operating Temperature for rooftop (extended temperature model) -40°F to 158°F (-40°C to 70°C)

Shipping and Storage -13°F to 167°F (-25°C to 70°C)

Agency Listings

UL Listing UL864 UUKL (except rooftop model)
UL864 UUKL7 (except rooftop model)
CAN/ULC-S527-M8 (except rooftop model)
UL 916 PAZX (all models)

cUL Listed Canadian Standards C22.2 No. 205-M1983, PAZX7
47 CFR Part 15

FCC Compliance

WEEE

RoHS

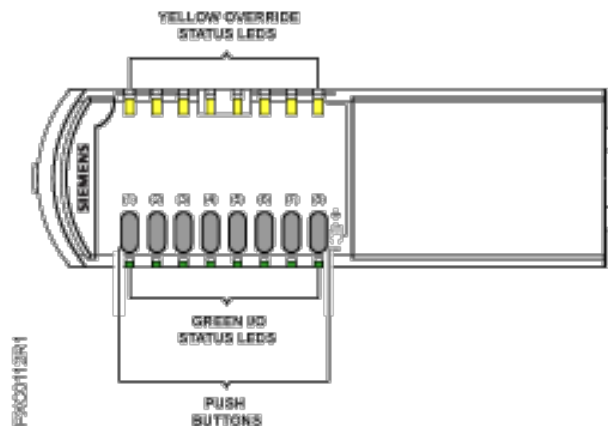

Using the HOA Switches

LED and Override Status



Placing Device into Override

To manually override the present value of an analog or digital output on the TC Compact, you must engage the appropriate switch assigned to the desired equipment to be controlled.

Pressing the center of the switch  enables the Override mode and energizes the Yellow Override status LED. Pressing the center of the switch  a second time, disables the Override and de-energizes the Yellow Override status LED.

Analog Output Override

Once a switch assigned to an analog output is placed into manual override, pressing the **+** or **-** switch will increase or decrease the value of the assigned point in 10 incremental steps. Based on the present value of the intensity of the Green I/O status LED (10 intervals up and down), the Yellow Override status LED will flash momentarily for any change in value.

The Green I/O status LED indicates the current value of physical points. The intensity of the Green I/O status LED will increase or decrease incrementally as the value changes.

Manual Control Settings for Analog Outputs			
Switch Position	% Output (LED Intensity)	Voltage Mode Output [V]	Current Mode Output [mA]
0	0%	0	4
1	10%	1	5.6
2	20%	2	7.2
3	30%	3	8.8
4	40%	4	10.4
5	50%	5	12
6	60%	6	13.6

Manual Control Settings for Analog Outputs			
7	70%	7	15.2
8	80%	8	16.8
9	90%	9	18.4
10	100%	10	20

Digital Output Override

Pressing the **+** switch causes the output to turn ON and the Green I/O status LED is ON at 100%.

Pressing the **-** switch causes the output to turn OFF and the Green I/O status LED is OFF at 0%.

The Yellow Override status LED will flash momentarily for any change in value.

Analog Input LED Feedback

Pressing the HOA switch has no effect on the point value or override status.

- Pressing the HOA switch causes the Yellow Override status LED to flash momentarily to indicate contact has been made.
- The Green I/O status LED on the HOA module contains the intensity that best represents the value of the analog input point. The intensity of the Green I/O status LED is determined by the message that the TC Compact firmware sends to the HOA about the value of the LAI. For example, if the value is 12.5 mA on a point that can go from 4 to 20 mA, then the Green I/O status LED will be as bright as 50% of its intensity.

Digital Input LED Feedback

Pressing the HOA switch has no effect on the point value or override status.

- Pressing the HOA switch causes the override status Yellow Override status LED to flash momentarily to indicate contact has been made.
- The Green I/O status LED on the HOA module is either ON or OFF depending on the value of the Digital Input point. The intensity of the Green I/O status LED is determined by the message that the TC Compact firmware sends to the HOA about the value of the LDI. For example, if the value is ON, the Green I/O status LED will be as bright as 100% of its intensity; otherwise, it is 0%.

Pulsed Points LED Feedback

Pressing the HOA switch has no effect on either LED.

The Yellow Override status LED status light on the HOA pulses ON/OFF depending on the signal of the pulsed input point.

The intensity of the Green I/O status LED is determined by the message that the TC Compact firmware sends to the HOA about the value of the pulsed input point. For example, if the value is ON, the Green I/O status LED will be as bright as 100% of its intensity; otherwise, it is 0%.

Inverted Inputs

If an AI or DI is inverted, the Green I/O status LED corresponds to the status of the physical point. The logical point displays the opposite. For example, if the physical point is ON the Green I/O status LED will also be ON and the logical point will be OFF.

Default Mapping

For each type of TC Compact (16, 24 and 36) that supports HOA and each HOA unit (8, 16 rooftop or 16 non-rooftop UL 864), there is a default mapping between each button and physical point.

The default mapping provides Plug-and-Play functionality. Upon connection of the HOA Upgrade Kit to the host field panel, the HOA device is recognized and its switches are automatically assigned to the controllers fixed digital output and fixed analog output points. The default mapping is also used to allow the HOA board to command physical outputs before any logical points have been defined. If a logical point is defined using a physical address that is mapped to an HOA switch by default the logical point value will correspond to the current Hand and I/O status of the HOA switch.

The HOA mapping and definition of a logical point in the database can be done in any order.

Default Mapping for HOA (8 button)		
TC Compact	Switch Number	Point Number
TC -16	1-3	DOs 14,15,16
	4-6	AOs 9,10,11
	7 and 8	Unused ¹⁾
TC -24	1-5	DOs 20-24
	6, 7, 8	AOs 17,18,19
TC -36	1-8	DOs 29-36

¹⁾ Available for custom mapping.

Default Mapping for HOA (16 button)		
TC Compact	Switch Number	Point Number
TC -16	1-3	DOs 14,15,16
	4-6	AOs 9,10,11
	7-16	Unused ¹⁾
TC -24	1-5	DOs 20-24
	6, 7, 8	AOs 17,18,19
	9-16	Unused ¹⁾
TC -36	1-8	DOs 29-36
	9-16	Unused ¹⁾

¹⁾ Available for custom mapping.

PXM10S/T Product Overview and Description

**NOTE:**

All figures show the BACnet version of the PXM10S and PXM10T. The appearance of the proprietary version may differ slightly.

PXM10S and PXM10T are optional controller mounted Operator Display modules that provide a password protected user interface. This interface allows you to interact with the existing field panel database and its immediate sub-networked Siemens (FLN) devices. (Optional remote enclosure door mount kit also available.)

**NOTE:**

All unacknowledged alarms are viewable even if you are not logged into the module.

Product Description

The PXM10S and PXM10T modules are available as an upgrade for use with all Siemens Compact and Modular Series field panels to provide additional local operator capabilities. The PXM10S and PXM10T modules are field mounted and replace the field panel covers.

There are three dedicated buttons, ALARM, INFO, ESC and one push DIAL. These buttons, the push dial, and LCD display screen allow for interactive feedback at the field panel controller.

The PXM10S and PXM10T modules support all the languages loaded in the host field panel.

There are two versions of the modules as follows:

- PXM10S has all available options, including Point Monitor and optional blue backlight color.
- PXM10T does not include the Point Monitor or the optional blue backlight color.

Language selection and user account timeout settings are configurable using an operator workstation or HyperTerminal at the field panel's HMI.

All PXM10S/T preferences are panel-specific and stored in the local panel configuration data.

**NOTE:**

For more information on creating and configuring user accounts, see the TALON Firmware User's Manual (588-580) (588-580).

Product Features

The PXM10S and PXM10T modules provide the following features:

- Plug and Play - Upon connection to the host field panel, the device is recognized and fully functional.
- Hot Swappable – The module can be installed or removed without powering down the controller and interrupting facility operations.
- User-friendly navigation and menu structure.
- Push DIAL for easy operation.
- Alarm button with red LED indicator for local alarm annunciations.

- INFO button provides one touch access to detailed system information for points.
- Manual and automatic login option for enhanced security or easy access.
- View point information and status, view and acknowledge alarms, and command/release local field panel points.
- Point Monitor – Can customize a group of points to continuously display and refresh with updated values (PXM10S only).
- Multi-language (English, Simplified Chinese, French, and Korean) support.
- The PXM10S and PXM10T modules can also be mounted on the inside or outside of an enclosure door, using an optional accessory sold separately.

Communication Connections

A field panel fully powered and running Firmware Revision 3.2.2 or later, recognizes the PXM10S and PXM10T modules within approximately 5 seconds of connection. Prior to that, the Operator Display is not operational.

If a field panel is coldstarted or it's the first time the panel is powered up, it takes approximately 15 to 30 seconds after connection before the PXM10S and PXM10T module is operational.

Requirements

System Requirements

The PXM10S and PXM10T modules can be used with Compact platforms (TC-36, TC-24, and TC-16), as well as with the TC Modular field panels.

- All hardware must be installed.
- Power must be available to all devices.
- System components must be installed, running, and checked out by an appropriate system representative.

Hardware Platform

The PXM10T and PXM10S modules can be used on all Siemens Compact and Modular series controllers. An additional connecting ribbon cable (part number PXA-HMI.CABLEP5) is required when mounting to a PXC16 or PXC24.

Firmware Platform

The PXM10T and PXM10S modules are compatible with all Siemens Compact and Modular series controllers using Firmware Revision 3.2.2 or later (proprietary protocol/BACnet).

Application Menus

The following application menus are provided with the PXM10S and PXM10T modules.

- Login
- Alarms
- Points (Command and Release)
- Point Monitor
- Logoff
- Settings



NOTE:

You must have sufficient operator access permissions to the Alarms, Points, and Point Monitor applications to fully use all features and corresponding submenus.

Operator Display Layout

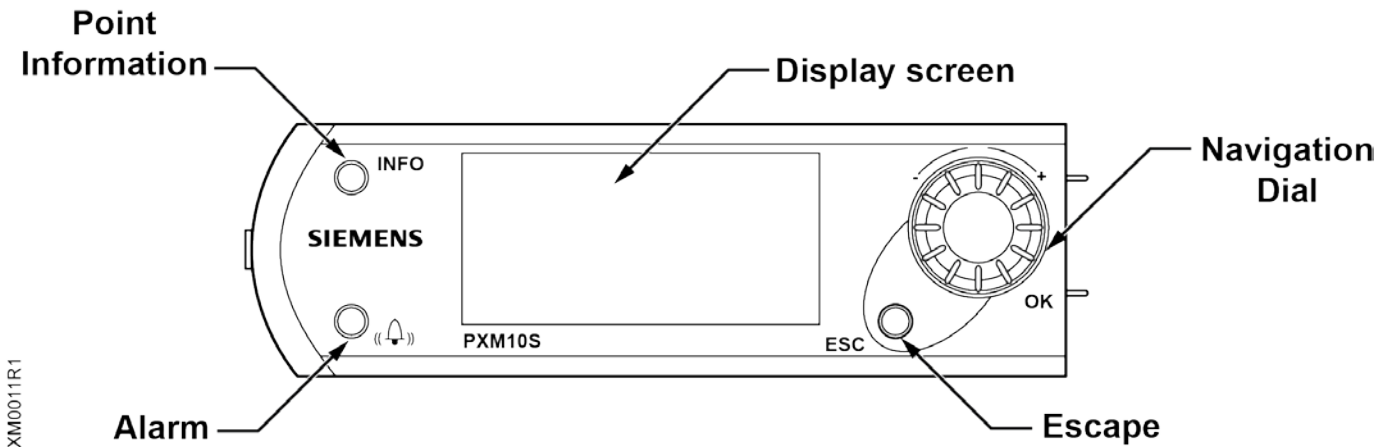

PXM0011R1

Display screen – Displays splash screen with either PXM10S or PXM10T module, device Firmware Revision, field panel Firmware Revision number, and Cimetrics BACstac revision number. Cursor position is indicated by either a right-angled bracket (>) or inverted text color, depending on field panel type and revision.

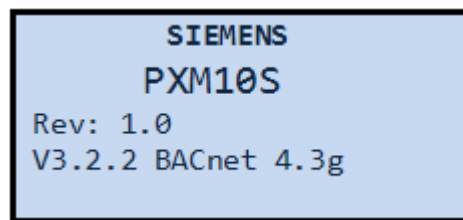

Figure 4: Splash Screen



NOTE:

If text information is too long for the display screen, the text scrolls horizontally across the screen, in a marquee style. If a high-priority task (such as a back-up) is being performed, the horizontal scrolling may be erratic.



NOTE:

The list of objects (once it is created) that displays for the Alarms, Points, and Point Monitor menus is static, however, the point information (current value, status, priority, etc.) is dynamic. You must leave the menu/page and return to it in order to view any updated information.

Navigation Push DIAL – Rotate clockwise or counter clockwise to highlight menu options (up or down). Press the dial to enter a menu or to make a selection. Rotate the dial to change a value. Pressing the dial is equivalent to selecting **OK**.

ESC button – Press once to return to previous menu/page or backspace during text/value editing.

INFO button – Press once to navigate to the window containing all available information about the point on selected line.

Alarm Window

There are two ways to view alarms, both of which display the alarm list with the point system name and status:

- **Alarm button.** Provides direct access to the list of unacknowledged alarms.
- **Alarm menu.** Displays any point in alarm, regardless if it has been acknowledged or not and provides three generic filters:
 - Unacknowledged Alarms filter allows you to filter all alarms and lists only unacknowledged alarms in local system.
 - All Alarms filter allows you to view all acknowledged and unacknowledged alarms in the system.
 - Failures/Faults filter allows you to view all failures/faults in the system for which alarming has been enabled.

Pressing the **INFO** button for point information displays:

U8	
System Name	U8
Ack Pendi	Ack Pendi
OFFNORMAL	Enabled
Time	09:46:45

Figure 5: INFO for Alarms

Press **ESC** to close alarm window without affecting the alarm.

Operator Display Menu Tree

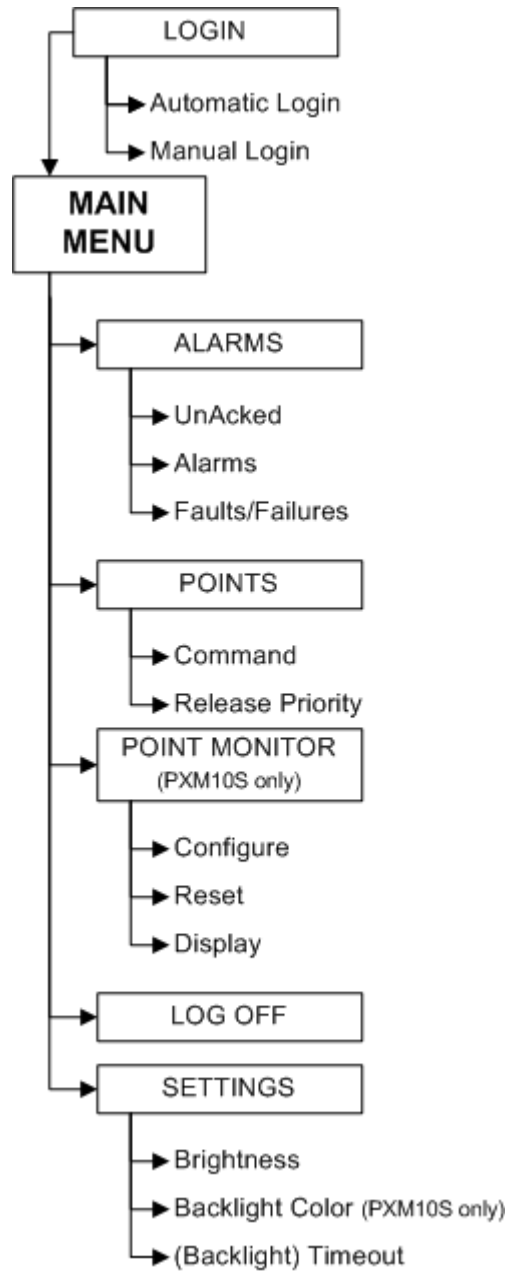

Main Menu Structure

All menu screen captures in this manual reflect the PXM10S module. Not all menu options/features shown are available with the PXM10T module.



NOTE:

A solid DOWN arrow in the top right corner of the display screen indicates more menu options are available and a solid UP arrow indicates more items are available after the last highlighted item.

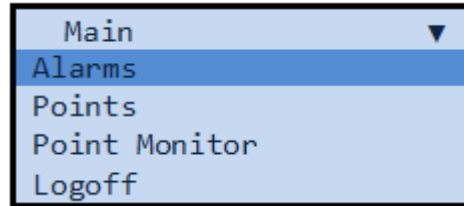

Figure 6: Main Menu

Alarms - Allows you to view and acknowledge alarms and failures/faults. However, you must be logged in with sufficient permissions (at least Command or Edit/Configure level access) to acknowledge an alarm.

Points - Allows you to view, command, and release the host field panel's onboard points and sub network points (FLN devices). To command and release points, you must have Command or Edit/Configure level access permissions.

Point Monitor - Displays a submenu, which allows an operator to configure and display a custom grouping of point and their values. The values are refreshed every four seconds. To configure points, you must have Edit/Configure level access permissions.

LogOff - Displays screen for confirming logoff.

Settings - Displays a submenu and screens that allow you to customize the LCD's display settings.

Login and Logoff

You must have at least Read Only level access permission to log in to the PXM10S or PXM10T module. If you log in and you have no access level permissions, the system will immediately log you off the module.

After three failed login attempts, the user account will be locked. An administrator must use the HMI to unlock the user accounts by modifying that particular user account. Also, you can only change your password for the PXM10S or PXM10T modules from the HMI.

Logging In

Automatic Login

The PXM10S or PXM10T automatic login feature must be configured using the host field panel's HMI port. Only one user account can be flagged as the automatic login account.



NOTE:

Default user account login information for PXM10S or PXM10T is on a per ALN account basis.

If your network contains an assortment of field panels with Firmware Revisions earlier than 3.2.2, the AutoLogin account is not replicated or passed onto other field panels. For more information about workstation user accounts, see the TALON View *Online Help* system.

Configuring AutoLogin at the HMI with HyperTerminal

Complete the following steps to configure an automatic login using HyperTerminal at the host field panel's HMI.

You must be logged into the field panel with an account that has Edit level access permission to the user's access group.

HMI	S, U, A, E, A (System, Users, Accounts, Edit, Add)
------------	---

Prompt/Field	Option/Entry	Description
User initials		Type the new user's initials.
Account name		Type the account name.
Password		Type a password for the user.
Verify password		Retype the password.
System, User namespace	S	View System point names.
	U	View User point names. (default setting)
Access group(s)	All groups.	(default setting).
	A single access group.	Valid value 1 through 30.
	Multiple access groups.	Valid values 1 through 30 separated by commas, or use two periods to indicate a range (for example, 1..4,7,9,12..20).
Privilege NOTE: Auto User accounts need access to Point and Alarm ONLY.	Point	N (No_access) R (Read_only) C (Command) E (Edit) (default setting)
	Alarm	N (No_access) R (Read_only) C (Command) E (Edit) (default setting)
	Trend	N (No_access) R (Read_only) C (Command) E (Edit) (default setting)
	Application	N (No_access) R (Read_only) C (Command) E (Edit) (default setting)

	PPCL	N (No_access) R (Read_only) C (Command) E (Edit) (default setting)
	FLN devices	N (No_access) R (Read_only) C (Command) E (Edit) (default setting)
	Equipment Scheduler	N (No_access) R (Read_only) C (Command) E (Edit) (default setting)
	System	N (No_access) R (Read_only) C (Command) E (Edit) (default setting)
	Diagnostics	N (No_access) R (Read_only) C (Command) E (Edit) (default setting)
	Users	N (No_access) R (Read_only) C (Command) E (Edit) (default setting)
	Hardware	N (No_access) R (Read_only) C (Command) E (Edit) (default setting)
Language ID	Language	Default
	Particular language.	Language ID, ? displays all available languages. NOTE: You can also enter nothing, to display all available languages.
Time format	(HH:MM:SS)	Default
	Particular format.	Time format; ? displays all available formats. NOTE: You can also enter nothing, to display all available Time formats.
Date format	(MM/DD/YYYY)	Default
	Particular format.	Date format; ? displays all available formats. NOTE: You can also enter nothing, to display all available Date formats.
AutoLogoff enabled (Y/N)	Y	Enable automatic logoff.
	AutoLogoff delay.	1 to 1440 minutes.
	N	Disable automatic logoff.
Password Expire Limit		0 to 365 days.
Use for PXM10Tiny AutoLogin (Y/N)	Y	Enable automatic login.
	N	Disable automatic login.

Example

```
>User initials           : tiny
>Account name           : PXM10TINY-----
---
>Password               : ?????-----
>Verify password       : ?????-----
>System, User namespace : U
>Access group(s)       : 1..30-----
-----
>Point privilege - No_access, Read_only, Command, Edit: E
>Alarm privilege - No_access, Read_only, Command, Edit: E
>Trend privilege - No_access, Read_only, Command, Edit: E
>Application privilege - No_access, Read_only, Command, Edit: E
>PPCL privilege - No_access, Read_only, Command, Edit: E
>FLN devices privilege - No_access, Read_only, Command, Edit: E
>Equipment Scheduler privilege - No_access, Read_only, Command,
Edit: E
>System privilege - No_access, Read_only, Command, Edit: E
>Diagnostics privilege - No_access, Read_only, Command, Edit: E
>Users privilege - No_access, Read_only, Command, Edit: E
>Hardware privilege - No_access, Read_only, Command, Edit: E
>Language ID           : 0409
>Time format           : HH:MM:SS---
>Date format           : MM/DD/YYYY-
>AutoLogoff enabled (Y/N) : Y
>AutoLogoff delay      : 5---
>Password Expire Limit : 30-
>Use for PXM10Tiny AutoLogin (Y/N): Y
User account <tiny> added
```



NOTE:

For more information on creating and configuring user accounts, see the TALON Firmware User's Manual (588-580) (588-580).

Do the following to automatically log in to the PXM10S or PXM10T module.

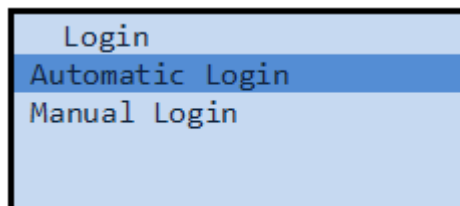

Figure 7: Automatic Login Submenu

Menu/Submenu	Step	Description
Splash screen/logo	Press the dial.	
	Rotate the dial to highlight Automatic Login .	Login menu displays.
Login	Press the dial to select Automatic Login .	System logs you into the Main menu of the module.

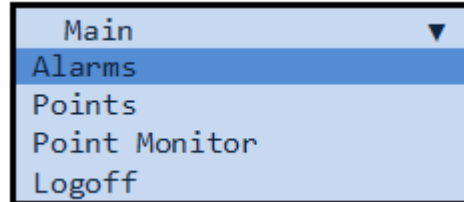

Figure 8: Main Menu

Manual Login

Do the following to manually log in to the PXM10S or PXM10T module. The default language for manual login is U.S. English.

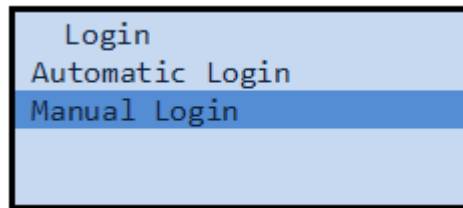

Figure 9: Manual Login Submenu

Menu/Submenu	Step	Description
Splash screen/logo	Press the dial.	
	Rotate the dial to highlight Manual Login .	Login menu displays.
Login	Press the dial to select Manual Login .	Displays the Manual Login submenu.
Manual Login	USR **** PWD *****	Enter your user name (up to 4 characters) and password (3 to 15 characters). A one character username is allowed. NOTE: You can only use capital letters A through Z for user name and passwords.
	For USR , rotate the dial to highlight each character.	
	Press the dial to select each character. Repeat until you enter the complete user name.	NOTE: If you make a mistake selecting a character, press ESC to return to the previous character.

Menu/Submenu	Step	Description
	Press the dial twice to move to the PWD fields.	
	For PWD , rotate the dial highlight each character.	
	Press the dial to select a character. Repeat until you enter the complete password.	NOTE: If you need to return to the previous editable field, for example from PWD fields back to USR fields, press ESC . To proceed to the next field, press the dial.
	Press the dial to confirm USR and PWD.	System logs you into the Main menu of the module.

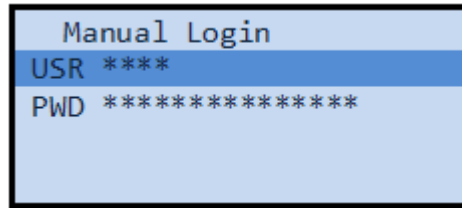

Figure 10: Manual Login Screen

Logging Off

There are three ways to log off.

- Automatic logoff – Occurs when the module interface has been idle for the amount of time defined in the user account settings. The timer feature is configured when a user account is created at the field panel.
- Manual logoff – Select **Logoff** on the screen – Prompts you to confirm logoff.
- Press **ESC** on the Main menu screen – Prompts you to confirm logoff.



NOTE:

When you log off the module, the screen may go blank for approximately two seconds.

Do the following to manually log off the PXM10S or PXM10T module.

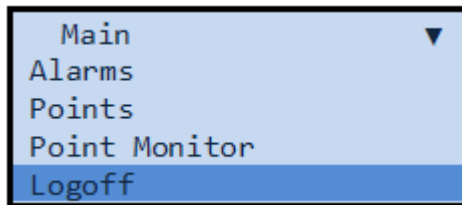

Figure 11: Logoff Menu

Menu/Submenu	Step	Description
Main	Rotate DIAL to highlight Logoff .	
	Press DIAL/OK to and select Logoff .	Displays the Logoff submenu.
Confirm Logoff Are you sure?	Rotate DIAL to highlight Yes or No .	
	Press DIAL/OK to make selection.	Confirms logoff and returns to splash screen. NOTE: If you press ESC , you are prompted with the same Confirm Logoff screen.

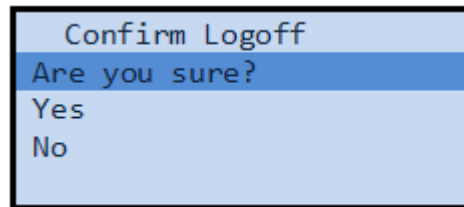

Figure 12: Confirm Logoff Submenu

Viewing, Commanding, and Releasing Points

Viewing Points

All points displayed on the screen are listed alphabetically, by system name.



NOTE:

Only four lines (excluding the title) of points are listed at a time for the English and French language.

Only three lines (excluding the title) of points are listed for the Chinese and Korean language.

Do the following to view and scroll to the next series of points in the field panel.

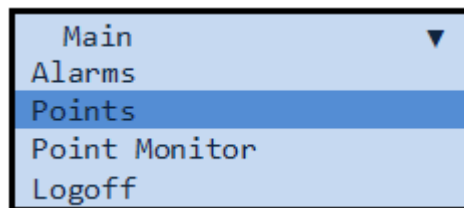

Figure 13: Points

Menu/Submenu	Step	Description
Main	Rotate DIAL to highlight Points .	
	Press DIAL/OK to select Points .	Displays the Points menu.
Points	Press DIAL/OK to highlight desired point.	
	Press DIAL/OK to select point.	

Menu/Submenu	Step	Description
	Rotate DIAL to highlight the last point (bottom of screen), and then rotate DIAL once more.	Refreshes the screen and displays the previous screens last highlighted point, as well as the next series of points.
	Repeat steps until you reach the end of the point list.	The number of points you can enter is dependent on the number of points stored at the host's field panel database, and sub network devices connected/configured to the host's field panel you are connected to.
	Press ESC .	Returns you the Points menu.
	Press INFO .	Displays detailed point information of selected point.

Points ▼	
stName:Address	41943
U7	5.01
U8	7.51
X5	5.00

Points ▲	
U7	5.01
U8	7.51
X5	5.00
X6	7.50

Scrolling the List of Points

The point name is displayed in the left column and values in the right column.

For TECs, the prefix is the TEC name; and the exposed point in the Points menu is the DAY.NGT subpoint. To see a complete list of the devices subpoints, highlight the DAY.NGT point, and then press **DIAL/OK**.

Points ▼	
EUT:Address	41943
t1:DAY.NGT	DAY
U7	N
U8	N

t1 ▼	
APPLICATION	2092
ROOM TEMP	74.00
RM STPT DIAL	74.00
AUX TEMP	74.00

TEC Subpoints Menu with List of Device Subpoints



NOTE:

Based on FLN speed and network traffic, there may be a delay in displaying a full point database.

Commanding Points

Do the following to change the point value and command the points in the field panel. These steps also apply to commanding TEC subpoints.

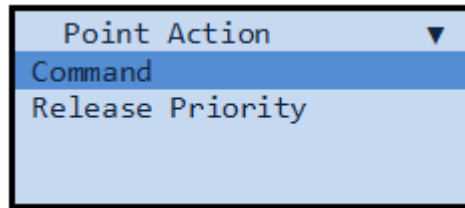

Figure 14: Point Action Command Submenu

Menu/Submenu	Step	Description
Main	Rotate DIAL to highlight Points .	
	Press DIAL/OK to select Points .	Displays the Points menu.
Points	Press DIAL/OK to highlight desired point.	Displays the Point Action Command submenu.
Point Action	Rotate DIAL to highlight Command .	
	Press DIAL/OK to select Command .	Displays the point name in title. Lists the selected point's current value, edit (highlighted) and priority fields.
[selected point name]	With Edit field highlighted, rotate DIAL to each numeric character and decimal, and press DIAL/OK after each numeric increment, including decimal character, until you enter the new value.	Changes the specified point value.
	Press DIAL/OK .	Confirms the point value change and moves to the Priority field.
	With Priority field highlighted, repeat steps to change priority of selected point. NOTE: This field is BACnet-specific. P2 firmware always commands at a priority of OPER.	Confirms the point priority change and returns you to the Points menu.
	Press ESC .	Returns you to the previous menu without changing the point value or priority.

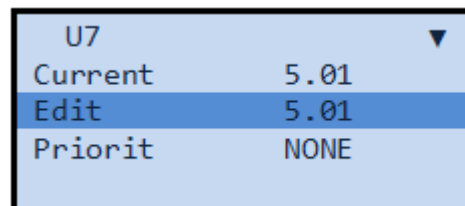

Figure 15: Command Point Value Submenu

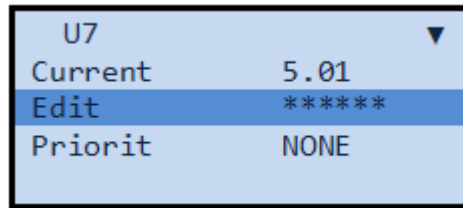

Figure 16: Edit Command Point Value Submenu

Releasing Points

Do the following to change a point priority and release a point.

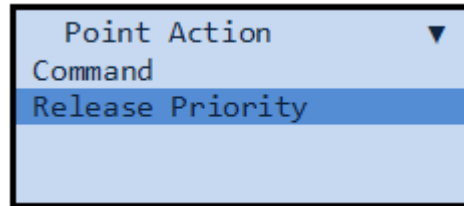

Figure 17: Point Action Release Priority Submenu

Menu/Submenu	Step	Description
Main	Rotate DIAL to highlight Points .	
	Press DIAL/OK to select Points .	Displays the Points menu.
Points	Rotate DIAL to highlight desired point.	
	Press DIAL/OK to select point.	Displays the Point Action Release Priority submenu.
BACnet Point Action	Rotate DIAL to highlight Release Priority .	
	Press DIAL/OK to select Release Priority .	NOTE: BACnet point priorities cannot be commanded lower than a priority value of 8.
	Rotate DIAL to change the numeric value of the point priority.	
	Press DIAL/OK to edit point priority.	
	Rotate DIAL to change point priority value.	
	Press DIAL/OK to confirm change.	Releases BACnet point priority.
	Press ESC .	Returns you to the previous menu without changing the point priority.

Menu/Submenu	Step	Description
P2 Point Action:	Rotate DIAL to highlight Release Priority .	
	Press DIAL/OK to select Release Priority .	
	Rotate DIAL to select Yes or No. Press DIAL/OK.	This releases the priority to NONE.
	Press ESC .	Returns you to the previous menu without changing the point priority.

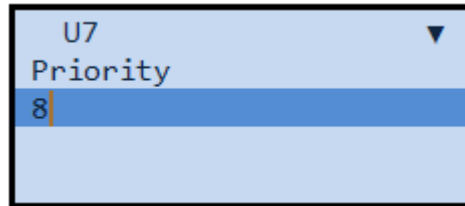

Figure 18: Release Priority Value Submenu

Configuring Point Monitor



NOTE:

This application and its sub-features are only available with the PXM10S module.

The Point Monitor allows you to select the points you frequently need to monitor and allows quick access to view a point status. This concept is similar to a Favorites list.

The maximum number of points listed and stored in Point Monitor is 10. You cannot add more points to the Point Monitor once you reach the maximum number.

Reset/clear the Point Monitor of stored points and then add the desired set of 10 or fewer points you want to monitor.



NOTE:

Depending on user access rights, previously added points (by other users) to the Point Monitor may not be visible. In this situation you can't see or add any points in Point Monitor. If this happens, you must first reset the Point Monitor to purge the old information. This affects all users. While Point Monitor information can't be retrieved, the field panel database is not affected.

Configuring Points for Point Monitor

Do the following to configure the host field panel's points for monitoring in Point Monitor after logging in.

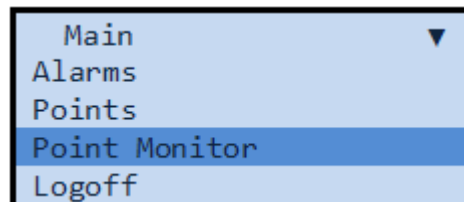

Figure 19: Point Monitor

Menu/Submenu	Step	Description
Main	Rotate DIAL to highlight Point Monitor .	
	Press DIAL/OK to select Point Monitor .	Displays the Point Monitor menu.
Point Monitor	Rotate DIAL to highlight Configure .	Displays all available points at the field panel.
	Press DIAL/OK to select Configure .	
Edit Pt Monitor	Rotate DIAL to highlight desired point.	Displays black background, allowing you to edit field.
	Press DIAL/OK to select point.	
	Press DIAL/OK to select Y or N .	Y=Yes; point is monitored. N=No; point is not monitored. (This is the default setting.)
	Press DIAL/OK to select Y or N .	
	Press ESC .	Returns you to the Monitor menu.

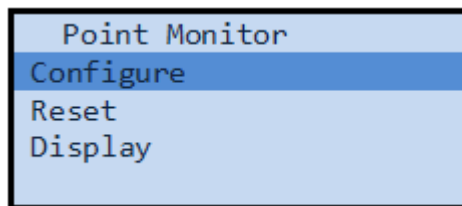

Figure 20: Configure Submenu

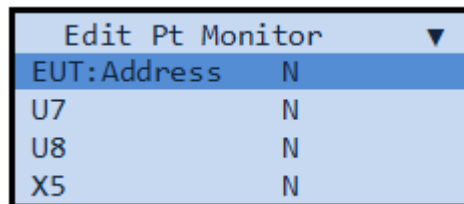

Figure 21: Edit Point Monitor Submenu

Do the following to configure bundled points in Point Monitor.

Menu/Submenu	Step	Description
Main	Rotate DIAL to highlight Point Monitor .	
	Press DIAL/OK to select Point Monitor .	Displays the Point Monitor menu.
Point Monitor	Rotate DIAL/OK to highlight Configure .	Displays all available points at the field panel.
	Press DIAL/OK to select Configure .	

Menu/Submenu	Step	Description
Edit Pt Monitor	Rotate DIAL to select desired point.	Displays all available points and subpoints at the field panel.
Subpoints	Rotate DIAL to select subpoint.	Displays a list of subpoints associated with the selected point.
	Press DIAL/OK to select Y or N .	Y=Yes; point is monitored. N=No; point is not monitored. (This is the default setting.)
	Press ESC .	Returns you to the Point Monitor menu.

Resetting Point Monitor

Do the following to reset points in the Point Monitor.

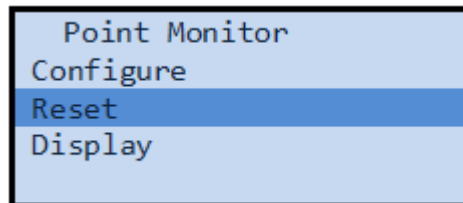

Figure 22: Reset Submenu

Menu/Submenu	Step	Description
Main	Rotate DIAL to highlight Point Monitor .	
	Press DIAL/OK to select Point Monitor .	Displays the Point Monitor menu.
Point Monitor	Rotate DIAL to highlight Reset .	
	Press DIAL/OK to select Reset .	Displays the Remove Monitor submenu.
Remove Monitor	Rotate DIAL to highlight point.	
	Press DIAL/OK to make select point.	
Remove Monitor Are you sure?	Rotate DIAL to highlight Yes or No .	Confirms you want to remove a point(s) from being monitored.
	Press DIAL/OK to make selection.	
	Press ESC .	Returns you to the Monitor menu.

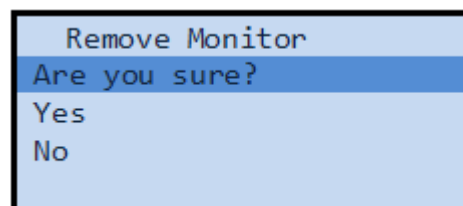

Figure 23: Remove Monitor Submenu

Displaying Monitored Points

Automatic logoff occurs after a predetermined amount of inactivity, however:

- The Point Monitor continues to display points and refreshes the Display screen every four seconds.
- You can scroll the Point Monitor, but the function keys (INFO, ESC, Alarm) are disabled.
- If you press any of the key functions, the login splash screen prompts you to login.

Do the following to display monitored points.

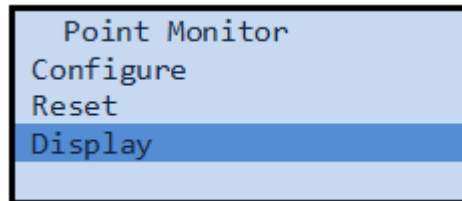

Figure 24: Display Submenu

Menu/Submenu	Step	Description
Main	Rotate DIAL to highlight Point Monitor .	
	Press DIAL/OK to select Point Monitor .	Displays the Point Monitor menu.
Point Monitor	Rotate DIAL to highlight Display .	
	Press DIAL/OK to select Display .	Displays the Display submenu.
Display		Displays the monitored points; one point and its value per line. Up to 10 points can be added the Point Monitor list.
	Press ESC .	Returns you to the Monitor menu.

Configuring Settings

Brightness

Do the following to modify the Brightness feature.

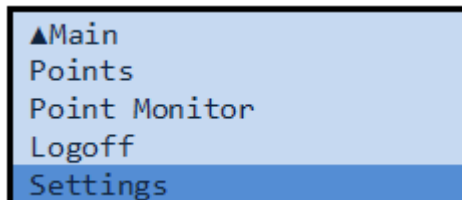

Figure 25: Settings Menu

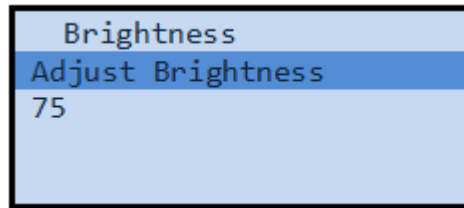

Figure 26: Adjust Brightness Submenu

Menu/Submenu	Step	Description
Main	Rotate DIAL to highlight Settings .	
	Press DIAL/OK to select.	Displays the Settings menu.
Settings	Press DIAL/OK to highlight Brightness .	
	Press DIAL/OK to select Brightness .	Displays the Brightness submenu.
Brightness	Rotate DIAL to highlight Adjust Brightness .	
	Press DIAL/OK to select Adjust Brightness .	
	Rotate DIAL to select a value.	Valid brightness values are 0 through 100.
	Press DIAL/OK to make selection.	Applies the value and returns you to the previous menu.
	Press ESC .	Returns you to the Settings menu without applying the new value.

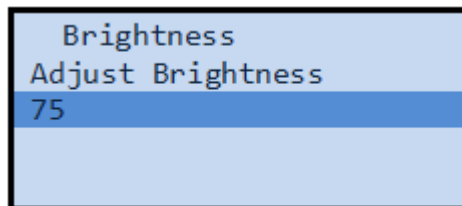

Figure 27: Brightness Submenu

Color



NOTE:

The Color feature is available only for the PXM10S module.

Do the following to modify the Color feature.

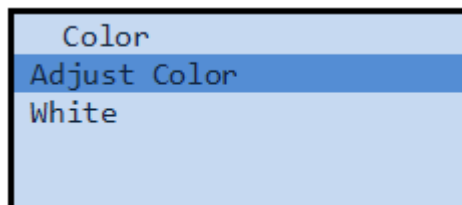

Figure 28: Adjust Color Submenu

Menu/Submenu	Step	Description
Main	Rotate DIAL to highlight Settings .	
	Press DIAL/OK to select.	Displays the Settings menu.
Settings	Press DIAL/OK to highlight and select Color .	Displays the Color submenu.
Color	Rotate DIAL to highlights and select Adjust Color .	
	Rotate DIAL to toggle between Blue and White color.	Displays the backlight color you choose.
	Press DIAL/OK to select.	Applies the value and returns you to the previous menu.
	Press ESC .	Returns you to the Settings menu without applying the new color.

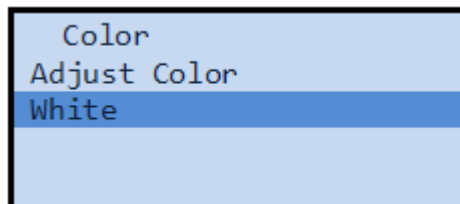

Figure 29: Color Submenu

Timeout

The PXM10S and PXM10T modules automatically turn off the backlight on the Display screen after a predetermined amount of inactivity. However, when you press any key, the backlight turns on again. If Point Monitor was active on the screen during this time, the point list is saved, even if you are logged off.

Do the following to modify the Timeout feature.

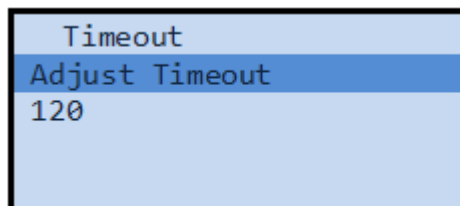

Figure 30: Adjust Timeout Submenu

Menu/Submenu	Step	Description
Main	Rotate DIAL to highlight Settings .	
	Press DIAL/OK to select.	Settings menu displays.
Settings	Press DIAL/OK to highlight and select Timeout .	Displays the Timeout submenu.

Menu/Submenu	Step	Description
Timeout	Rotate DIAL to highlight and select Adjust Timeout .	
	Rotate DIAL to select a value.	Valid Timeout values are 0 through 240 seconds.
	Press DIAL/OK to select.	Applies the value and returns you to the previous menu.
	Press ESC .	Returns you to the Settings menu without applying the new value.

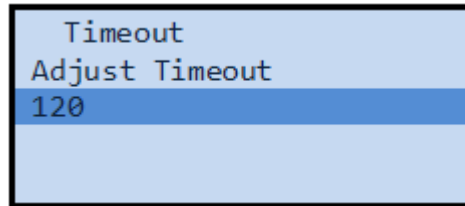

Figure 31: Timeout Submenu

Unitary Equipment Controller

The Unitary Equipment Controller (UEC) is a BACnet MS/TP only controller (TC-16/24 hardware platform). Although intended primarily to be connected as an FLN device (shipped from the factory in FLNnode mode), the UEC can be switched to run in ALNnode mode and connected as an MS/TP ALN device. In which case the UEC behaves like an ALN device.

- The UEC can reference external objects using either Device Specific Name or BACnet Encoded Name.
- Functionality of the UEC Ethernet port is limited to Telnet and FTP.
NOTE: Newer models do not support Ethernet ports.
- The UEC supports the PXM10S and PXM10T controller mounted operator display modules.
- The UEC does not support HOA modules (PXA8-M, PXA16-M, PXA16-MR).
- Scheduling, trending, and alarming are limited to local objects. The following BIBBS are not supported:
 - AE-N-E-B (External Algorithmic Alarming)
 - T-VMT-E-B (External Trend)
 - SCHED-E-B (External Schedule)



NOTE:

If a Host/Supervisory field panel references a UEC subpoint, the Host panel must be upgraded to Firmware Revision 3.2.2 or later.

FLN Node Mode

When the UEC is operating in FLNnode mode, it has the capability to monitor points from other devices, and recognize the point by device specific name, or BACnet encoded name. However a point log display should show only points that reside locally on the UEC.

Some functions, depending on the exchange of proprietary messages, such as replication, and database download, are not available. BACnet Encoded names or device specific names must be used for referencing external objects.

- Only visible to the Web Server when defined as a FLN device.
- Operates on the FLN without replication.
- Cannot be programmed from an ALN device, if added as an FLN device.
- Recognized as a Siemens device.
- Exposes application number and default subpoint.
- Supports failure detection of the UEC by other nodes.
- Limited support of failure detection of other nodes by the UEC, only when defined as a node of interest.
- No global data such as BLN User account or State Text tables support.
- No database upload and download from TALON View but database can be saved in panel flash memory.
- Proprietary messages generated using HMI are processed as usual.
- Proprietary messages received using comm port from TALON Commissioner processed as usual.
- Save, upload and download database information using Field Panel Web Server UI (FPWeb UI) and Siemens Launch Pad.
- PPCL Assist for programming over the network using FPWeb UI and Siemens Launch Pad.
- Field panel support for FIN Builder graphics with Firmware Revision 3.3.1 and later.
- Support for totalization for analog and multistate points with Firmware Revision 3.4 and later.

ALN Node Mode

When the UEC is operating in ALNnode mode, it retains the capability to monitor points from other devices and recognizes the point by system name, device specific name, or BACnet encoded name.

All functions depending on the exchange of proprietary messages, such as discovery, replication, and database download, are available. System name, device specific name and BACnet encoded names are supported for referencing external objects.

- Only visible to TALON Commissioner for editing and commissioning when defined as ALN device.
- Time is synchronized with the TALON View workstation.
- In the event of a network failure, the UEC independently maintains control of the time and scheduling, trending, and alarming.
- An Integration FLN, with Integration Driver support for FPWeb allows FLNs to be viewed and modified from FPWeb UI in Kiosk mod.

Unitary Equipment Controller Specifications

Dimensions (L × W × D)

TC Unitary Equipment Controller, 16 point, BACnet MS/TP	10.7" × 5.9" × 2.45" (272 mm × 150 mm × 62 mm)
TC Unitary Equipment Controller, 24 point, BACnet MS/TP	10.7" × 5.9" × 2.45" (272 mm × 150 mm × 62 mm)
DIN rail (EN 60715 TH 35-7.5, steel)	1.38" × 0.30" × 0.04" (35 mm × 7.5 mm × 1 mm)

Processor, Battery, and Memory

Processor and Clock Speed	Freescale MPC852T, 100 MHz
Memory	24 MB (16 MB SDRAM, 8 MB Flash ROM)
Serial EEPROM	4 KB
Battery backup of Synchronous Dynamic (SD) RAM (field replaceable)	AA (LR6) 1.5 Volt Alkaline (non-rechargeable) 180 days (accumulated) Typical Accumulated Battery Life of Compact UEC: 16MB SDRAM Std (alkaline): 180 days <i>Rooftop (Extended Temperature) Models: 330 days (accumulated)</i> AA (LR6) 3.6 Volt Lithium (non-rechargeable)
Battery backup of Real Time Clock	10 years (32°F to 122°F (0°C to 50°C)) Coin cell (BR2032) 3 Volt lithium These are typical accumulated times while power is off. Rooftop (Extended Temperature) Models 18 months
BACnet MS/TP Field Level Network (FLN)	9600 bps to 115.2 Kbps <i>Factory-set HMI Communication Speed</i> 9600 bps

Electrical

Power Requirements	24 Vac ±20% input @ 50/60 Hz
Power Consumption (Maximum)	TC-16: 18 VA @ 24 Vac TC-24: 20 VA @ 24 Vac TC-36: 35 VA 24 Vac
AC Power and Digital Outputs	NEC Class 1 Power Limited
Communication and all other I/O	NEC Class 2
Digital Input	Contact Closure Sensing Dry Contact/Potential Free inputs only Does not support counter inputs

Electrical

Digital Output	Class 1 Relay
Analog Output	0 to 10 Vdc
Universal Input (UI) and Universal Input/Output (U)	<p>Analog Input Voltage (0-10 Vdc) Current (4-20 mA) 1K Ni RTD @ 32°F 1K Pt RTD (375 or 385 alpha) @ 32°F 10K NTC Type 2 or Type 3 Thermistor @ 77°F 100K NTC Type 2 Thermistor @ 77°F</p> <p>Digital Input Pulse Accumulator Contact Closure Sensing Dry Contact/Potential Free inputs only Supports counter inputs up to 20 Hz</p> <p>Analog Output (Universal Input/Output (U) points only) Voltage (0-10 Vdc)</p>
Super Universal (X)	<p>Analog Input Voltage (0-10 Vdc) Current (4-20 mA) 1K Ni RTD @ 32°F 1K Pt RTD (375 or 385 alpha) @ 32°F 10K NTC Type 2 or Type 3 Thermistor @ 77°F 100K NTC Type 2 Thermistor @ 77°F</p> <p>Digital Input Pulse Accumulator Contact Closure Sensing Dry Contact/Potential Free inputs only Supports counter inputs up to 20 Hz</p> <p>Analog Output Voltage (0-10 Vdc) Current (4-20 mA)</p> <p>Digital Output (requires an external relay) 0 to 24 Vdc, 22 mA max.</p>

Operating Environment

Ambient operating environment	Operate in a dry location, which is protected from exposure to salt spray or other corrosive elements. Exposure to flammable or explosive vapors must be prevented.
Ambient operating temperature	32°F to 122°F (0°C to 50°C)
Relative Humidity	5 to 95% rh non-condensing
Shipping and storage environment	-40°F to 185°F (-40°C to 85°C)
Mounting Surface	Direct equipment mount, building wall, or structural member <i>CE Compliance</i> Must be installed inside a metal enclosure rated at IP20 minimum
Vibration	Compliance to IEC 60721, Class 2M2 and 3M2
Protection to EN60529	IP 20

Agency Listings

UL	UL916 PAZX (all models) UL916 PAZX7 (all models)
Agency Compliance	FCC Compliance CFR47 Part 15, Subpart B, Class B Australian EMC Framework European EMC Directive (CE) European Low Voltage Directive (LVD)BACnet Testing Laboratories (BTL) Certified, Firmware Revision 3.0 and later

Electrical Disturbance Testing

Dips and Interrupts	per EN 61000-4-11
Electrical Fast Transients (EFT)	per EN 61000-4-4 1 kV signal, 2 kV AC power
Electrical Surge Immunity	per EN 61000-4-5 AC power: 2 kV common mode, 1 kV differential mode
Electrostatic Discharge (ESD)	per EN 61000-4-2, 6 kV contact, 8 kV air discharge
RF Conducted Immunity	per EN 61000-4-6 @ 10V
RF Radiated Immunity	per EN 61000-4-3 @ 10V/m

TX-I/O Product Range Overview

TX-I/O™ is a range of I/O modules, with associated power and communication modules, for use within the TALON System. The I/O modules communicate between the TC Modular or the TC-36 and the related devices in the building services plant.

The TX-I/O product range includes the following:

- Eight types of I/O modules, which act as signal converters.
- TX-I/O Power Supply for the TX-I/O modules.
- TX-I/O Bus Connection Module, which bridges communication and power from one DIN rail to another.

TX-I/O Module Overview

TX-I/O Modules are modular expansion I/O consisting of an electronics module and a terminal base; they receive power from a TX-I/O Power Supply or Bus Connection Module.

- The electronics module performs A/D or D/A conversion, signal processing, point monitoring, and command output.
- The terminal base provides for termination of field wiring and connection of the self-forming TX-I/O island bus.

All TX-I/O modules provide the following features:

- DIN rail mounting.
- High density point count (compared to physical dimensions).
- Hardware addressed with address keys.



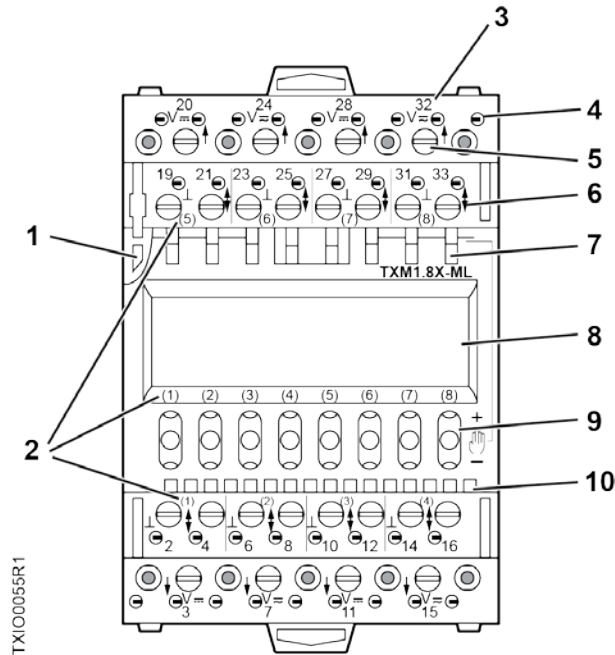

The design of the TX-I/O Modules provides optimum diagnostics and results in a more efficient installation and maintenance workflow.

- Field wiring may be terminated prior to installation of electronics.
- Connected peripheral devices can be measured without affecting or being affected by the I/O module.
- Hot-swappable electronic components allow powered electronics to be disconnected and replaced without removing terminal wiring or disturbing the self-forming bus.

TX-I/O Module Product Diagram















TX-I/O Module Symbols and Status LEDs			
	LED, Symbol, or Feature	LED or Symbol	Indication
1	Address key and module status LED (green)	-	Module status as a whole (as opposed to the I/O points).
		ON	Normal operation. 24 Vac (supply voltage) input present; fuse is intact.
		OFF	Error. - No 24 Vac (supply voltage) input. - Fuse is blown.
		Flashing or pulsing	- Fault indication - No address key - Remote override
2	I/O point numbers	-	-
3	Terminal number	-	-
4	Test terminal	-	
5	Connection terminals	-	
6		-	System neutral.
		-	Configurable point.



























TX-I/O Module Symbols and Status LEDs			
	LED, Symbol, or Feature	LED or Symbol	Indication
		-	Output (arrow pointing OUT from center of module).
		-	Input (arrow pointing IN toward center module).
		-	24 Vdc output (field supply).
		-	24 Vac output (field supply).
7	Override status LEDs (yellow)	ON	Manual operation; a local override is active.
		OFF	No voltage or manual operation off.
		Flashing or pulsing	- Override action - Remote override - Output: Local override is off, operation is not possible. - Input: Operation is not possible.
8	LCD signal panel	-	Only on a TX-I/O modules with –ML suffix.
9	Local override switch	-	Only on a TX-I/O with –M or –ML suffix.
10	I/O status LEDs (green)	-	Status of the inputs and outputs (peripheral devices). LEDs are labeled with the I/O point number.
		ON	Binary value indication.
		OFF	No voltage or binary value indication.
		Flashing or pulsing	- Fault indication - Activity of field devices - Module unconfigured, no address key - Analog value indication

TX-I/O Module LCD Symbol Chart

The TX-I/O module LCD displays a symbol to indicate each point type and its current value.

TX-I/O Module LCD Panel for Errors and Reminders (Displays in LCD Top Row)	
	Value above range limit
	Value below range limit
 Open Circuit	Open circuit
 Short Circuit	Short circuit
 illegal	Point type invalid for use with manual override
 No Sensor	No sensor (current)
 No Output	No output signal
 Point Definition	24 Vdc supply < 22 Vdc

TX-I/O Module LCD Panel for Errors and Reminders (Displays in LCD Top Row)	
 Inactive Point	Inactive point
 Invalid Value	Invalid value
 No Voltage	No voltage
 Unconfigured	Unconfigured point

TX-I/O LCD Panel by Point Type.			
Point Type (Displays in LCD Bottom Row)		Normal Operation (Displays in LCD Top Row)	
Analog Input, Current		 Low Value  High Value	Low or high value
Analog Input, Resistance	 Nickel Input  Platinum Input  Resistance Input	 Temperature	Temperature
Analog Input, Voltage	 Voltage Input	 Low Value  High Value	Low or high value
Analog Output, Current		 Low Value  High Value	Low or high value
Analog Output, Voltage		 Low Value  High Value	Low or high value
Digital Input, Counter			Step indicator
Digital Input, N/C Contact	 DI N/C Contact	 N/C Inactive  Inactive	 N/C Active  Active
Digital Input, N/O Contact	 DI N/O Contact	 Inactive	 Active

Address Keys

I/O modules are addressed using a TX-I/O address key.

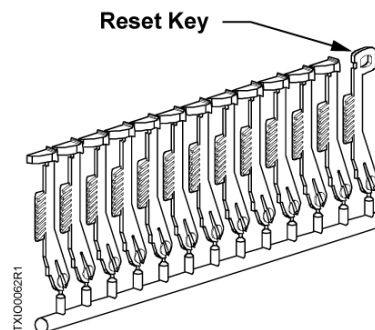

Figure 32: TX-I/O Module Keys.

The keys are available in sets of 24, up to a maximum value of 72 (two sets of 12, 1-24, 25-48, and 49-72).

- The I/O module address is mechanically encoded in the address key.
 - Without an address key, the module is inactive.
 - With an address key inserted, the module has full functionality.
- Based on the address, the TC-1000 or TC-36 configures the I/O module, indicates which field devices are connected to this module, and which function is required for the field devices.

When replacing the plug-in I/O module, the address key must first be swiveled outward. This switches the load off but values remain saved in the TC-1000 or TC-36. The key remains plugged into the terminal base so that the TC-1000 or TC-36 can communicate the required function to the new I/O module.

Reset Key

The reset key sets the module back to the factory settings (default function on each of the I/O points):

- The reset key is inserted in place of the address key and then swiveled out again.
- The module indicates the reset by briefly lighting all its I/O status LEDs.
- Note that a reset is only possible when the module is supplied with 24 Vdc.

TX-I/O Power Supply and Bus Modules

The TX-I/O™ Power Supply and Bus Modules provide power, communications, and expansion options for the TX-I/O Island Bus.

Power and Communication Modules

The TX-I/O Power Supply and Bus Connection Module provide the following functions for the island bus:

Product	Function		
	TX-I/O Bus Communication	24 Vdc power	24 Vac power
TX-I/O Power Supply (TXS1.12F4)	Signal pass-thru	Output 28.8 W (1.2A at 24 Vdc)	<ul style="list-style-type: none"> • NEC Class 2 Output , 96 VA max., fused at 4A • Class 1 Power Limited Input, 150 VA max.
Bus Connection Module (TXS1.EF4)	<ul style="list-style-type: none"> • Signal pass-thru • Allows for external connection of I/O signals. 	Pass-thru	<ul style="list-style-type: none"> • NEC Class 2 Output, 96 VA max., fused at 4A • Class 1 Power Limited Input, 96 VA max.

NOTE: 10A versions are not sold in North America.

TX-I/O Power Supply Overview

The TX-I/O Power Supply bridges communication and power from one DIN rail to another and generates 28.8 W (1.2A at 24 Vdc) to power TX-I/O modules and peripheral devices.

- An LED provides an indication of 24 Vdc on the TX-I/O bus.
- Up to 4 TX-I/O Power Supplies can be operated in parallel, with a maximum of two per DIN rail.
- It can be located within a row of TX-I/O modules or at the beginning of a new DIN rail.

The TX-I/O Power Supply performs the following functions:

- Transfers 24 Vac at 4A to power TX-I/O modules and peripheral devices.
- Provides an input point for 24 Vac to power additional peripheral devices.
 - Isolates the 24 Vac peripheral device supply in case of overload or short-circuit.
 - The replaceable AC fuse can be accessed from an installed module.
 - Indicates the AC fuse status with an LED for easy diagnostics.
- Routes the bus signal between DIN rails (+24 Vdc Communication Supply (CS) and Communication Data (CD) signals).

Supply Terminal Connections

- 24 Vac supply terminals are fused (replaceable) for Class 2 (24 Vac at 50/60 Hz) through the TX-I/O Power Supply.
- 24 Vdc supply terminals are connected in the I/O module, not in the terminal base. 24 Vdc is supplied and overload protected in the TX-I/O Power Supply.

Bus Connection Module Overview

The Bus Connection Module bridges communication and power from one DIN rail to another. It provides the bus signal, module supply voltage, and field device supply voltage to TX-I/O Modules on an additional DIN rail.

The Bus Connection Module performs the following functions:

- Passes 24 Vac at 4A to power TX-I/O modules and peripheral devices.
- Provides an input point for 24 Vac to power additional peripheral devices.
 - Isolates the 24 Vac peripheral device supply in case of overload or short-circuit.
 - The replaceable AC fuse can be accessed from an installed module.
 - Indicates the AC fuse status with an LED for easy diagnostics.
- Routes the bus signal between DIN rails (+24 Vdc Communication Supply (CS) and Communication Data (CD) signals).

Supply Terminal Connections

- 24 Vdc is supplied to terminals one and four (CS) and to both ends of the TX-I/O bus connector for distribution to connected TX-I/O modules and external devices.
- 24 Vac is passed through an internal fuse from terminals three and four (system neutral) to the male TX-I/O bus connector.
- External devices draw power from the 24 Vdc, 24 Vac, and system neutral terminals on the TX-I/O modules.
- 24 Vdc supply terminals are connected in the I/O module, not in the terminal base. 24 Vdc is current-limited in the Bus Connection Module.

PX Series Enclosures and Service Boxes

PX Series enclosures house both electronic and pneumatic components. The enclosures include a perforated backplane for mounting TC Series field panels or other electronic or pneumatic components.

General features of the enclosures include:

- Availability in three sizes to match installation needs: 18-, 19-, and 34-inch.
- Sturdy construction, which accommodates secure conduit fittings and protects components against incidental contact and falling dirt.
- UL Smoke Control listed for indoor use (19- and 34-inch enclosures only).
- Multiple knockouts along the top and bottom.
- Perforated backplane, which extends wall-to-wall for mounting of additional equipment.
- Spacious interior for easy routing and termination of wiring.

The 18-inch enclosure is a pull-box type utility cabinet for low cost installations. It is equipped with the following:

- Factory-installed 16" × 12" perforated panel
- DIN rail and wire tie bar kit

The 19- or 34-inch PX series enclosures are equipped with the following:

- Factory-installed backplane assembly, which includes wire tie down rails and DIN rails
- Label pouch
- Hinged door and key lock
- Conduit knockouts and venting

PX Series Service Box Features

The PX Series Service Box Assemblies transform either 115 Vac or 230 Vac to 24 Vac sized for either 192 VA or 384 VA.

- The 192 VA service boxes mount directly inside a 19- or 34-inch PX Series Enclosure.
- The 384 VA service boxes provide additional power for larger systems and mount only in the 34-inch PX Series Enclosure.

The service boxes provide protection against electrical transients and are Smoke Control and Energy Management listed when installed according to the *Service Box Assemblies Installation Instructions* (553-131).

The service box assemblies consist of the following:

- Chassis for mounting inside enclosure.
- ON/OFF circuit breaker for transformer.
- Two Class 1 power limited 24 Vac outputs, which include one terminal for earth ground for use inside enclosure only.
- One Class 2 output with circuit breaker to distribute up to 96 VA for use outside the enclosure.
- Wire cover for field connections.
- Duplex Service Outlet (115 Vac models only).
- Optional sidewall kits PXA-SW192VA and PXA-SW384VA may be used for installation in third-party enclosures, such as motor control cabinets.

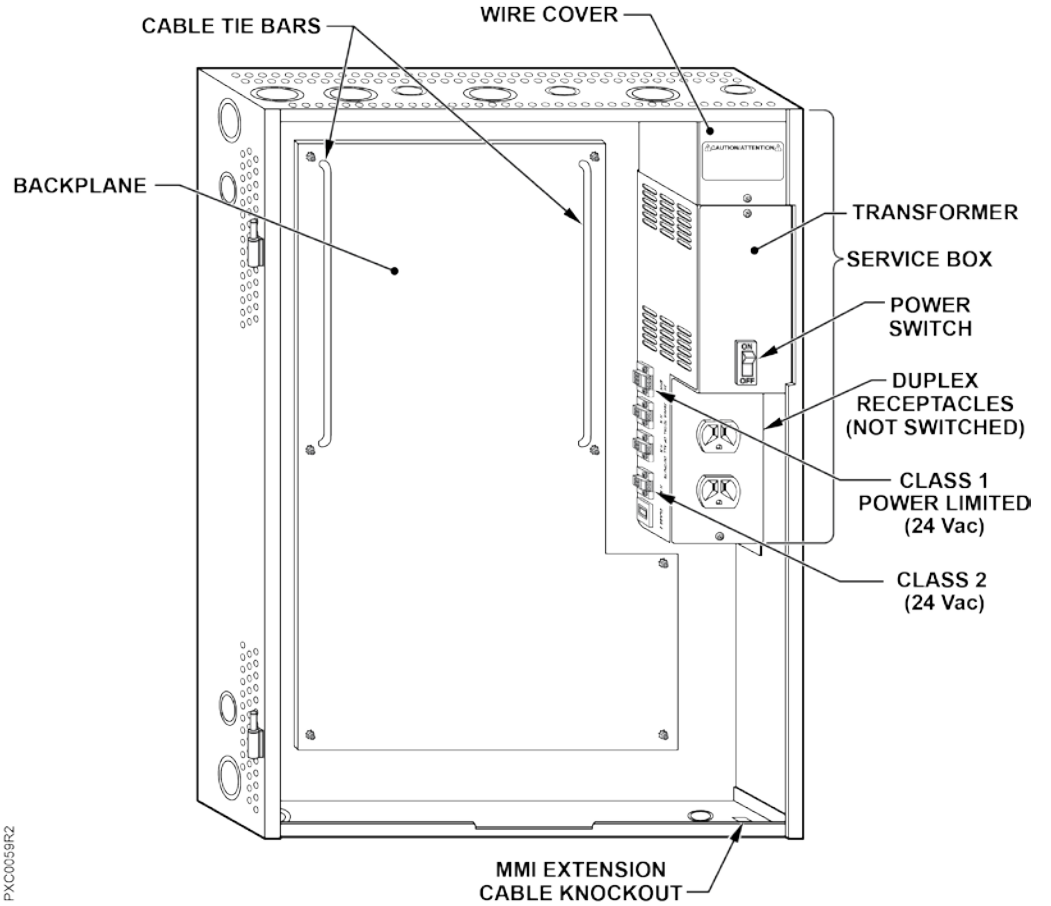

Figure 33: PX Series Service Box (115V), 34-inch enclosure.

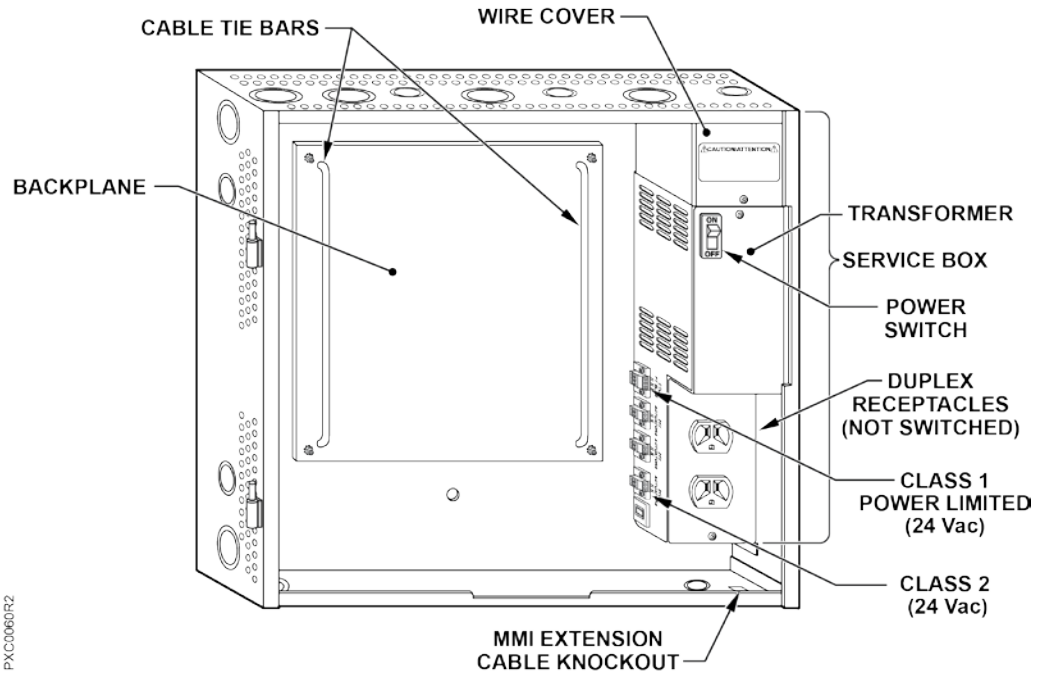

Figure 34: PX Series Service Box (115V), 19-inch enclosure.

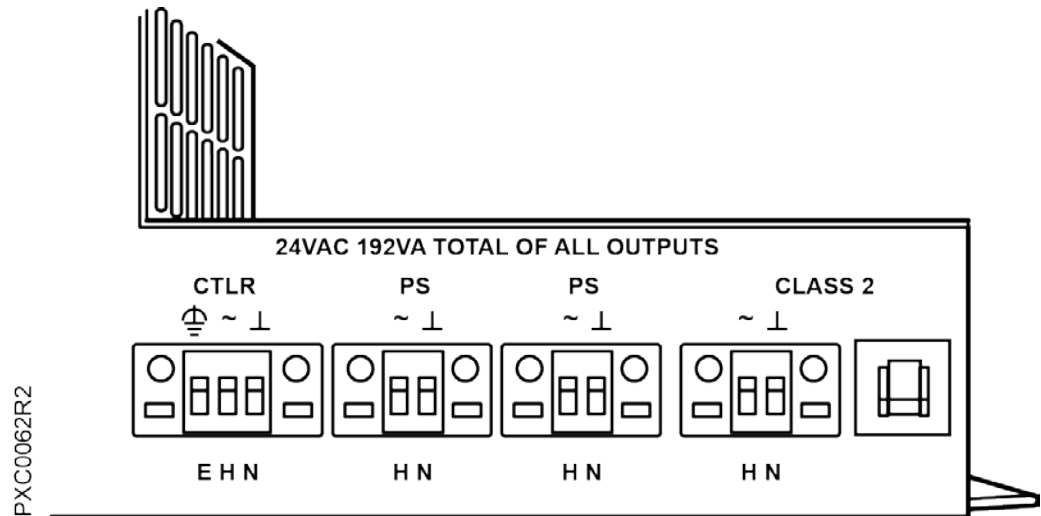

Figure 35: PX Series Service Box Connectors.

- Each Service Box distributes the total 24 Vac power provided to the plug-in terminations on the left side.
 - Two Class 1 power-limited terminations distribute up to the total power to controllers and power supplies inside the same enclosure.
 - Earth ground is provided on the CTLR termination.
 - One Class 2 termination distributes up to 96 VA to auxiliary devices outside of the enclosure.
- Each 115VAC Service Box has a duplex outlet on the front to power accessory devices such as modems and Portable Operator's Terminals.

Product Numbers

Product Number	Description
PXA-SB115V192VA	PX Series Service Box—115V, 24 Vac, 50/60 Hz, 192 VA
PXA-SB115V384VA	PX Series Service Box—115V, 24 Vac, 50/60 Hz, 384 VA
PXA-SB230V192VA	PX Series Service Box—230V, 24 Vac, 50/60 Hz, 192 VA
PXA-SB230V384VA	PX Series Service Box—230V, 24 Vac, 50/60 Hz, 384 VA
PXA-ENC18	18" Enclosure (Utility Cabinet) (UL Listed NEMA Type 1 Enclosure)
PXA-ENC19	19" Enclosure (UL Listed NEMA Type 1 Enclosure)
PXA-ENC34	34" Enclosure (UL Listed NEMA Type 1 Enclosure)

PX Series Enclosure Specifications

PX Series 18" Enclosure Specifications

Dimensions (H × W × D)

PXA-ENC18 18" × 14" × 6"
(457.2 mm × 355.6 mm × 152.4 mm)
UL Listed NEMA Type 1 Enclosure, Pull-box style

Operating Environment

Ambient operating environment +32°F to +122°F (0°C to +50°C), 93% rh (Non-condensing)
Mounting Surface Building wall or structural member (Do not mount on HVAC components or any other vibrating surface)

Agency Listings

Agency Compliance UL 508A (acceptable for UL 916 applications)
FCC Compliance

PX Series 19" and 34" Enclosure Specifications

Dimensions (H × W × D)

PXA-ENC19 19" × 22" × 5.75"
(482.6 mm × 558.8 mm × 146.05 mm)
UL Listed NEMA Type 1 Enclosure, Hinged Door with lock

PXA-ENC34 34" × 22" × 5.75"
(863.6 mm × 558.8 mm × 146.05 mm)
UL Listed NEMA Type 1 Enclosure, Hinged Door with lock

Operating Environment

Ambient operating environment +32°F to +122°F (0°C to +50°C), 93% rh (Non-condensing)
Mounting Surface Building wall or structural member (Do not mount on HVAC components or any other vibrating surface.)

Agency Listings

UL UL 864 UUKL Smoke Control Equipment
ULC-C100 UUKL7
UL 916 PAZX
UL 508A

Agency Compliance FCC Compliance
Australian EMC Framework - with metal enclosure, maximum opening size is 34"
European EMC Directive (CE) - with metal enclosure, maximum opening size is 34"
European Low Voltage Directive (LVD)

PX Series Service Box Specifications

Power Requirements for 115 Vac Service Boxes

PXA-SB115V192VA

Input: 115 Vac +/- 15%, 50/60 Hz +/- 5%, 220VA maximum, 2A CB
Output: 24 Vac +/- 20%, 50/60 Hz +/- 5%, 192VA maximum

PXA-SB115V384VA

Input: 115 Vac +/- 15%, 50/60 Hz +/- 5%, 440VA maximum, 4A CB
Output: 24 Vac +/- 20%, 50/60 Hz +/- 5%, 384VA maximum

115 Vac models also have a duplex outlet, which is protected by Mains 20A or 15A CB for use internal to enclosure to power laptop and peripheral devices.

Power Requirements for 230 Vac Service Boxes

PXA-SB230V192VA

Input: 230 Vac +/- 15%, 50/60 Hz +/- 5%, 220VA maximum, 1A CB
Output: 24 Vac +/- 20%, 50/60 Hz +/- 5%, 192VA maximum

PXA-SB230V384VA

Input: 230 Vac +/- 15%, 50/60 Hz +/- 5%, 440VA maximum, 2A CB
Output: 24 Vac +/- 20%, 50/60 Hz +/- 5%, 384VA maximum

Service Box Output Jacks

One 3-terminal and one 2-terminal NEC Class 1 output jack for use internal to enclosure to power system components.

One 2-terminal NEC Class 2 output jack with 4A CB for use external to enclosure to power actuators.

PX Series Enclosure Placement

	⚠ CAUTION
	<p>Do not mount the enclosure on ductwork, HVAC components, or any other vibrating surface.</p> <ul style="list-style-type: none"> • Mount the enclosure at least 12 feet (3.7 m) away from devices that can generate Radio Frequency Interference (RFI), such as Electro-pneumatic devices (EPs), relays, and walkie-talkies. • Mount the enclosure at least 5 feet (1.5 m) away from 100 kVA or larger motors and variable frequency drives (VFD).

	⚠ CAUTION
	<p>If the enclosure is mounted under a wire trough or any other obstruction, provide a minimum vertical clearance of 2 inches (50.8 mm) to allow for installation and removal of the enclosure door.</p>

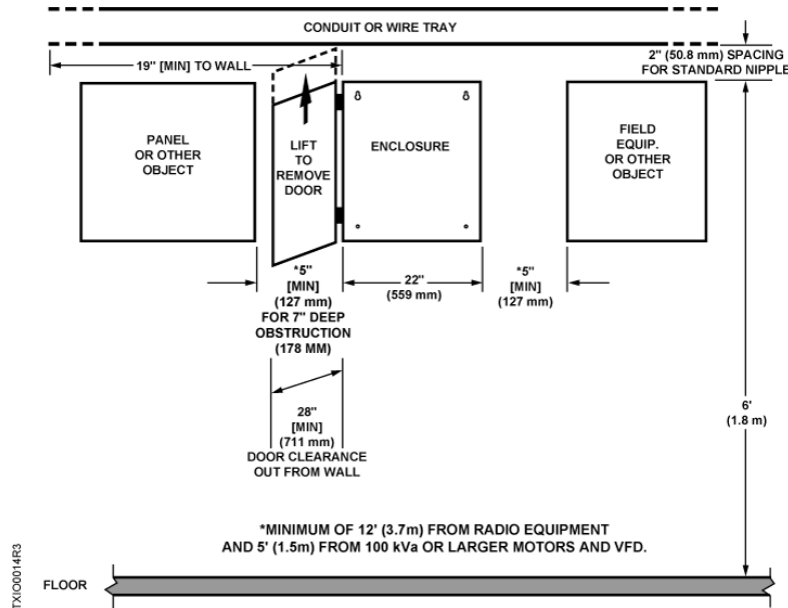
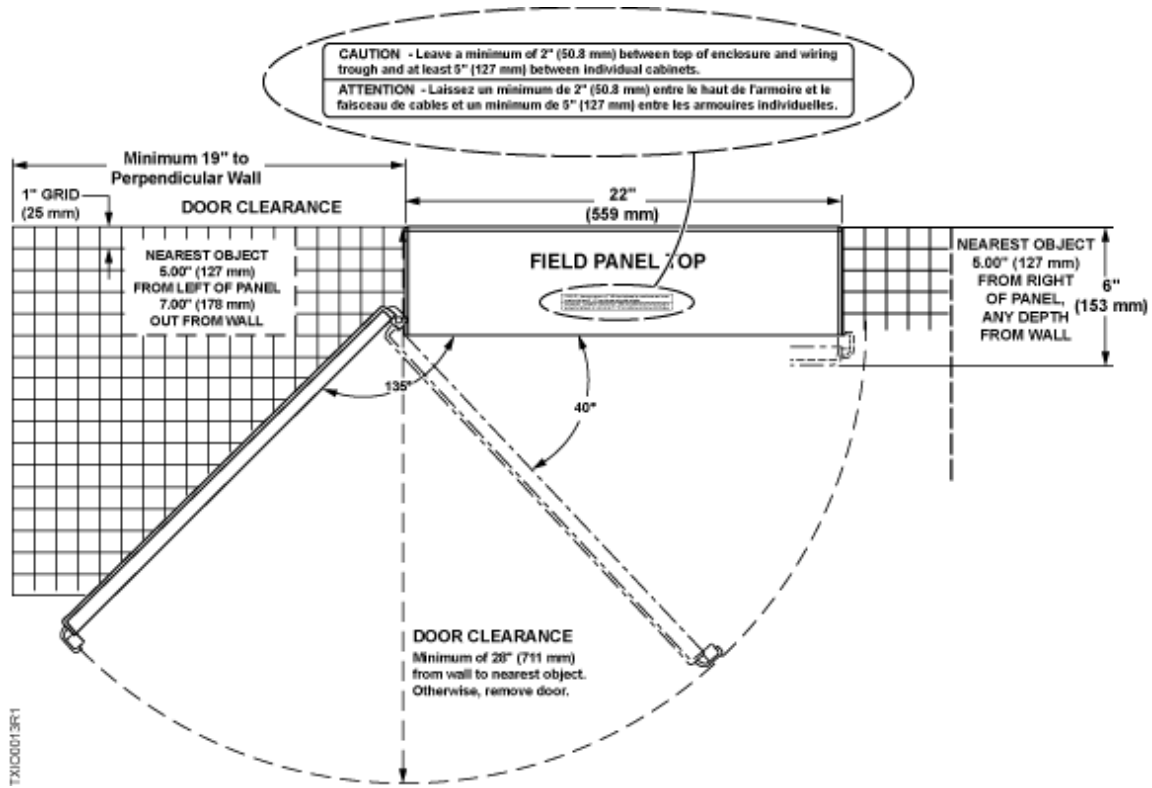

- Space between door panel and opening obstruction must be at least 11 inches (279.4 mm) to allow for door removal at 40 degrees, or 28 inches (711 mm) with a cabinet mounting at least 19 inches (483 mm) from the left side wall to allow door to completely open at 135 degrees.
- 5 inches (127 mm) minimum horizontal distance between the enclosure and any obstruction to the left and right.
- 7 inches (178 mm) minimum depth out from the wall on the left (hinged) side for door clearance.

Chapter 3—Applications

Chapter 3 describes the program and applications provided with or available for the TC Compact Series. The following topics are discussed in this chapter:

- Operator Interface
- Powers Process Control Language (PPCL) Point Database and Control Program
 - Control Programs
 - Point Database
- Applications
- Customized Applications

Operator Interface

An operator issues commands or requests to the TC Compact using an operator terminal and the operator interface. The operator interface is the software that allows the operator to communicate interactively with the TC Compact Series. The operator interface does the following:

- Interprets and processes commands entered from operator terminals.
- Formats and sends all output directed to the operator.
- Provides levels of operator access that control an operator's authority to perform certain functions.

The operator interface is described in detail in the TALON Firmware User's Manual (588-580). This manual is designed to help you become familiar with and use the operator interface. It describes the functions necessary for everyday operation of your system, plus the higher-level functions for commanding, displaying, editing, scheduling, networking, alarm management, and others.

Field Panel Web Server

The Field Panel Web Server encompasses the following operator applications:

- Graphical Monitoring and Control
- Network Layout
- System Status Bar
- Alarm Status and Acknowledgement
- Point Commanding
- Scheduling
- Graphical Trend Display
- Reporting
- Configuration and Customization
- Remote Notification

Graphics

- Customized system graphics
- Live animation of equipment
- Real-time point values and status updates

Network Layout

- View network layout
- Navigate to other Web-enabled panels
- Search database for individual points

System Status Bar

- Visual indication of new alarms and unacknowledged alarms
- Visual indication of out of service, faults, and failed devices
- Ability to view, filter, and acknowledge system alarms from a single page

Point Commanding

- Change point values
- Place points “Out of Service”
- Command BACnet MS/TP

Scheduler

- View schedules in a daily, weekly, or monthly view
- Add and delete schedules
- Create exceptions for existing schedules

Reporting

- Generate Point Log Report with multiple filters

Graphical Trend Display

- Ability to view one or more trends on a single display
- Ability to view raw data values and export to CSV file
- Print trend graph to network printers
- Display points with current values

Configuration and Customization

- Custom Welcome Page
- User interface translatable to any browser-supported language
- Ability to customize font sizes and display colors

Powers Process Control Language (PPCL) Control Program and Point Database

The control programs and point database are stored in RAM. This information can also be saved or loaded into the TC Compact using TALON Datamate software or TALON View software.

Control Programs

The control programs define all user-defined control logic, calculations, applications, and so on for the TC Compact. PPCL is written in an English-based programming language called Powers Process Control Language (PPCL). It is a powerful programming language developed specifically for controlling Heating, Ventilating, and Air Conditioning (HVAC) equipment. Multiple PPCL programs can be run simultaneously to provide instructions for the TC Compact to operate equipment, control system loads, and optimize the system operation.

For a complete description of PPCL and how to use it, see the TALON Powers Process Control Language (PPCL) User's Manual (588-583). This manual is available from your local Siemens Solution Partner, Authorized TALON Dealer.

Point Database

The TC Compact Series has the basic capabilities required to control and monitor a facility. However, the operator (or the installer) must program specific instructions into the TC Compact and create databases that are customized for your particular facility. The databases contain information, such as point names, addresses, schedules, and alarm information for the equipment being supervised by the TC Compact.

The TC Compact uses information from the point database to define each point so that the firmware and the software know how to evaluate or command the point. Among the items kept in the point database are the following:

- Location, or address of field inputs/outputs
- Logical point names and descriptions of points
- Point type
- Alarm information
- Current value of a point
- Information to convert analog signals to engineering units (slope and intercept constants)

The point database is described in detail in the TALON Firmware User's Manual (588-580).

Applications

Applications are an important part of the energy management capabilities of your system. The applications that you can incorporate into the operation of your system include:

- Alarm Management
- Daylight Saving Time
- Loop/Loop Tuning
- Trend Data Collection
- User Access and Privileges

Alarm Management

An alarm is a status that indicates whether a point value or state is above or below a defined value. Alarm management is the strategy used to define, route, acknowledge, and resolve those alarms.

Points are defined as alarmable for the following reasons:

- **To prevent critical problems.** Points that affect human safety or can cause a severe problem in building operation should be defined as alarmable. For example, an alarm that notifies you that the temperature of a heating coil is too low and action must be taken before it freezes.
- **To notify you when equipment is not functioning properly.** Sometimes problems may occur and go unnoticed. Alarming is a useful tool to identify equipment that is not working properly and to prevent other devices from becoming damaged.
- **To announce scheduled maintenance.** For example, an alarm can notify you when it is time to change air filters.

Daylight Saving Time

The Daylight Saving Time (DST) functionality adjusts the system time to match the daylight saving time change-over. If your area uses daylight saving time, this feature offers a convenient method to automatically adjust the system clock.

Loop/Loop Tuning

The loop application is the PPCL Proportional, Integral, Derivative (PID) control loop algorithm. The loop tuning application evaluates and calculates gains and sample times for existing LOOP statements in PPCL. This feature calculates appropriate Proportional, Integral and Derivative (PID) gains and sample time for a selected control loop, based on specific building and control information defined in the LOOP statement. When complete, you decide how to apply the newly calculated variables.

Trend Data Collection

Trending is a function that records point data over time. Trend data is either collected when the current point value changes by a specified amount (the trend COV limit), or point values are recorded after the system waits a specific amount of time and then the process is repeated.

Trend data can be uploaded from the field panel to the TALON View workstation for storage and reporting, and the data can be converted to several spreadsheet formats for further analysis and reporting.

User Access and Privileges

A user issues commands or requests to the TC Compact Series using an operator terminal and the operator interface program that resides in the TC Compact Series. The operations that a particular user can perform depend on the access level assigned to each field panel function in their user account.

User accounts are used to manage access and security for field panels on a specified Automation Level Network (ALN). By creating individual accounts, a system administrator can control each user's access to objects and functions residing in field panels on a specified ALN.

Specifically, a system administrator can perform the following tasks:

- Define the users that can access an ALN
- Assign access to access groups
- Assign privileges to field panel functions residing on an ALN

Controlling User Access to Field Panel Functions

The following four access levels can be assigned to any field panel function for any user.

- **No Access** – Users cannot see the function.
- **Read Only** – Users can only view the value or status of objects.
- **Command** – Users can command or display the value or status of objects.
- **Edit** – Users can add, delete, command, modify, and view objects.

Example

If a user has a Command access level for the Point Editing function, then only the functionality required to command a point is available to them. They do not see or have access to the prompts required to add, modify, or delete a point definition.

For more information on user accounts and privileges, see the TALON Firmware User's Manual (588-580) (588-580).

Customized Applications

Some TC Compact Series applications are created in the Powers Process Control Language (PPCL). These applications use PPCL statements and additional hardware to perform customized operations or functions in your system. Examples of applications created in PPCL include:

- Duty Cycling
- Enthalpy and Dry Bulb Economizer Control
- Peak Demand Limiting (PDL)

Information on how to customize these applications for your facility is included in the TALON Powers Process Control Language (PPCL) User's Manual (588-583) and the TALON Firmware User's Manual (588-580). These manuals are available from your Siemens Solution Partner, Authorized TALON Dealer.

SNMP

The Simple Network Management Protocol (SNMP) Agent is a firmware feature that has been added to BACnet Firmware Revision 3.2.3 and later. The SNMP Agent allows points in the field panel to communicate with an SNMP manager over Ethernet. SNMP is an application layer protocol that facilitates the exchange of management information between network devices. It is part of the Transmission Control Protocol/Internet Protocol (TCP/IP) suite. SNMP enables network administrators to manage network performance, find and solve network problems, and plan for network growth.

Three versions of SNMP exist: SNMP version 1 (SNMPv1), SNMP version 2 (SNMPv2), and SNMP version 3 (SNMPv3). All three versions have a number of features in common, but SNMPv2 offers enhancements such as additional protocol operations. SNMPv3 offers additional enhancements to Internet security and communities.



SNMP users UDP ports 161 and 162, which must be opened within the firewall settings.



The panel may coldstart after the SNMP license is loaded.

For more information, see the *SNMP Agent Quick Start Guide* (140-0891).

Chapter 4—Troubleshooting



NOTE:

The following information is for qualified service personnel only.

Chapter 4 describes corrective measures you can take if you encounter a problem with a TC Compact Series controller. If you encounter a symptom or a problem not covered in this manual, contact your Siemens Solution Partner, Authorized TALON Dealer. The following topics are discussed in this chapter:

- Service Information
 - Electrostatic Discharge Requirements
 - Error Status Messages
 - Ordering Replacement Parts
 - Replacing the Batteries
 - Reinstalling the Mounting Tabs
- Troubleshooting the TC Compact and TX-I/O Island Bus

Service Information

This section describes corrective measures you can take if you encounter a problem with a TC Compact Series controller.

If you encounter a symptom or a problem not covered in this manual, contact your Siemens Solution Partner, Authorized TALON Dealer.

**NOTE:**

When removing power to a controller to perform maintenance or service, make sure that the person in charge of the facility is aware of this and that appropriate steps are taken to keep the building in control.

**NOTE:**

When troubleshooting, record the problem and what actions were performed immediately before the problem occurred. Being able to describe the problem in detail is important should you need assistance from your local Siemens Solution Partner, Authorized TALON Dealer.

To view the status of the TC Compact and to call up reports for troubleshooting, you can use an operator's terminal and the operator interface or a TALON View workstation. For more information, see the following documentation:

- TALON Firmware User's Manual (588-580) (588-580).
- TALON View *Revision 3.x Documentation*. To view this documentation, see the TALON View Online Documentation window, which you can access from the TALON View Main Menu or the TALON View program group.

It is good practice to back up the TC Compact database routinely and whenever changes are made to the database or new equipment is added.

While performing the troubleshooting procedures outlined in this manual, you may wish to refer to the TALON Wiring Guidelines Manual (588-581).

Electrostatic Discharge

An electrostatic discharge (ESD) wrist strap is generally not required when installing or servicing a TC Compact. However, if the field panel is installed in a very dry environment where a high static discharge is likely, an ESD wrist strap is recommended.

Error Status Messages

For error status message descriptions, see the TALON Firmware User's Manual (588-580) (588-580).

Ordering Replacement Parts

If a TC Compact Series is not operating correctly, it should be replaced.

Replacing the Batteries



CAUTION

AC power must be ON during battery replacement. Otherwise, data loss will occur.



NOTE:

The battery is taped in the tray to secure it during shipping. The tape does not need to be replaced.

1. Pull the release tab on the curved side of the battery compartment cover.
2. Remove the battery compartment cover.
3. Remove the failed battery, and place a fresh battery in the tray with the positive (+) and negative (-) ends properly aligned.
 - For the AA battery, make sure the positive (+) and negative (-) ends are properly aligned.
 - For the coin cell battery, make sure the positive (+) side is facing up.
4. Replace the battery compartment cover.

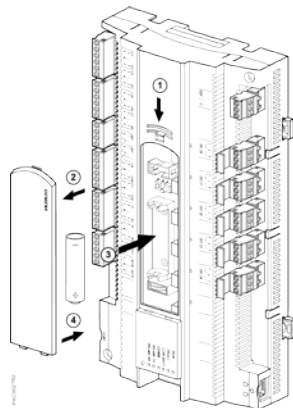

Figure 36: Replacing the AA Battery.

Reinstalling the Mounting Tabs

Do the following to reinstall a DIN mounting tab:

1. Place the wire spring clip into the pocket in the channel for the mounting tab.
2. Make sure the mounting tab is face down.
3. Working from the center (inside) of the base, slide the mounting tab into the channel. (See the following figure.)



NOTE:

The end with the screw hole slides into the channel first.

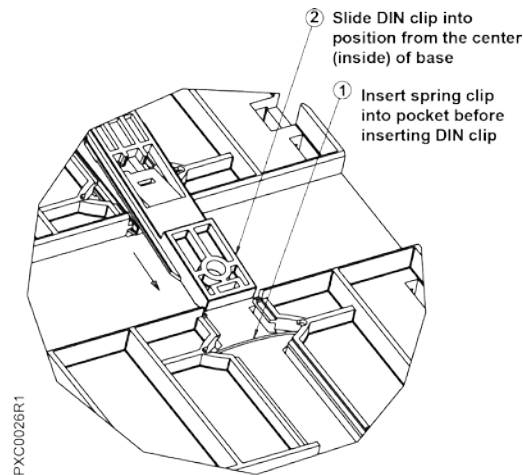

Figure 37: Reinstalling a DIN Mounting Tab.

Troubleshooting Compact Field Panels

Find the symptom below that best describes the problem and perform the corrective action that follows.

If the problem persists or other symptoms are present, contact your Siemens Solution Partner, Authorized TALON Dealer.

BATT LOW LED

The BATT LOW LED is on or the battery low warning is displayed at the operator's terminal.



CAUTION



If you do not have a current backup, save the database before continuing.

1. Check that the mylar insert was removed from the AA (LR6) battery holder.
2. Check for polarity (+ to +) and (- to -).

3. Check that the battery is properly seated in the battery holder.
4. Replace the battery.

BATT LOW LED remains on after the battery has been replaced.

- Verify that the correct type of battery is being used. The LOW BATT LED remains ON if an alkaline battery is used in TC Compact models with extended temperature range operation.

	 CAUTION
	<p>Only use a 3.6 Volt lithium battery in TC Compact models with extended temperature range operation.</p> <p>Only use a 1.5 Volt alkaline battery in standard TC Compact models.</p> <ul style="list-style-type: none"> • The 3.6 Volt lithium battery is designed to operate at both high and low temperature extremes, and it provides a long service life in an extended temperature environment. • The 1.5 Volt alkaline battery is not guaranteed to provide backup protection in models with extended temperature range operation, even if the controller is operating in a room-temperature environment. • If a 3.6 Volt lithium battery is used in standard TC Compact models, the battery quickly discharges and provides much less backup protection than a 1.5 Volt alkaline battery.

RUN LED

The RUN LED is on solid.

- The RUN LED is steadily lit during normal operation to indicate that 24 Vac power is ON and the application firmware has booted.

The RUN LED is ON. No communication is possible with the HMI port.

1. Verify that HMI port and your terminal are set to the same communication speed.
 - The factory-default communication speed of the TC-16 and TC-24 HMI port is 9600 bps.
 - The factory-default communication speed of the TC-36 HMI port is 115.2 Kbps.
2. Verify that the cable from the field panel to the operator's terminal is properly connected at both ends.
3. Open the enclosure and verify that both ends of the HMI extension cable are properly connected.
4. Unplug the extension cable and plug directly into HMI port.

The RUN LED is off.

1. Verify that power is connected.
2. Check the service box and transformer ON switches.
3. If power is ON, verify that the application firmware has booted.
4. Measure voltage on **24V~** and **⊥** (Terminals 1 and 2).

Communication

Points cannot be read or commanded from the operator's terminal.

1. Verify that failed points have been properly addressed.
2. Verify the status of the points at the operator's terminal. Verify that points are not under Operator priority.

No communication over the FLN trunk.

1. Verify the FLN address and communication speed.
2. Verify the FLN trunk is connected to the correct FLN port.

Errors

The error E3600(0x0E10) - Invalid FLN number displays when adding a point to a TC-16 or TC-24 with FLN support.

- Since the TC-16 and TC-24 support only one FLN port, only 0 or 1 can be entered for the FLN number.

TC Compact program and database are not down-line loading properly.

- Verify that the TALON View software is at least Revision 3.9.1 (TC-16 and TC-24) or 3.10 (TC-36).

Troubleshooting the TX-I/O Island Bus

All points on the TX-I/O island bus are failed.

1. Verify all three signals, System Neutral (\perp), Communication Data (CD), and Communication Supply (CS) are connected throughout the entire TX-I/O island bus.

The 24 Vac LED on the TX-I/O Power Supply is OFF.

1. Check for 24 Vac input.
2. Replace the fuse (4A, 5 × 20 mm, 250V, medium-acting, ceramic fuse).

The I/O module status LED (under the address key) is flashing or the I/O point status LED is flashing on an open point. All points are operating normally.



⚠ CAUTION

The TX-I/O™ island bus must extend from the male bus connector of the TX-I/O Power Supply or Bus Connection Module.

- The TX-I/O Power Supply and Bus Connection Module only supply 24 Vac to I/O modules on the male bus connector.
- I/O modules on the female bus connector of the TX-I/O Power Supply or Bus Connection Module do not receive power and have a fault condition.

A point is failed or the point type displayed does not correspond to the point type defined in the database.

1. Using the job drawing or TX-I/O Island Bus layout sheet, verify that the address keys are in the correct module.
2. Reset the module to factory settings.
 - Verify that the module is supplied with 24 Vdc.
 - Remove keys that are in the wrong module.
 - Insert and then remove the reset key.
 - Cycle power to the module.
 - Insert the correct address key.

A current point on a Super Universal Module is failed.

- Verify that the sensor supply wire is connected to the DC terminal (3, 11, 20, or 28).

Glossary

The glossary contains terms and acronyms that are used in this manual.

1

100Base-TX: Fast Ethernet network implementation. 100Base-TX stands for 10Mbps baseband twisted-pair cable. The “X” stands for 100Base-X, the IEEE identifier for the media system used by 100Base-TX.

10Base-T: Ethernet network implementation. 10Base-T stands for 10Mbps baseband twisted-pair cable.

A

alarm priority: Ranking of a point alarm.

analog input-electric: Analog input point that receives either a current, voltage, or resistance input signal.

analog output-pneumatic: Analog output point that outputs a pneumatic signal.

AO-V point: Physical analog output point that generates a voltage signal.

Automation Level Network (ALN): The level in the communication hierarchy that consists of automation stations, automation devices, Application-Specific Controllers (ASCs), etc.

B

BACnet: A data communication protocol for Building Automation and Control Networks, ANSI/ASHRAE Standard 135-2004. BACnet allows devices from multiple manufacturers to work together on a network.

BACnet Broadcast Message Device (BBMD): BBMDs pass BACnet Broadcast Messages to other BBMDs on the network, allowing these messages to reach BACnet devices on the other side of a subnet router.

BACnet Encoded Name: A numeric representation of an object name that exceeds the TALON standard of 30 alphanumeric characters or less per name.

BACnet/IP: BACnet over IP protocol.

BBMD: See *BACnet Broadcast Message Device*.

broadcast: Destination IP address that represents all interfaces on all hosts. Usually, this is restricted to all hosts on the local subnet.

C

command priority: Ranking of a point command.

current value: Last commanded or sensed value of a logical point.

D

Device ID: Uniquely identifies a device object on the BACnet Inter network.

Device Instance Number: A number assigned to a BACnet device (for example, a BACnet field panel) that uniquely identifies it on the BACnet/IP network.

Device port: A USB Device port supports a generic serial interface for an HMI or Tool connection.

Device Specific Name: A textual representation of a BACnet object name that meets the TALON naming standard of 30 alphanumeric characters or less.

digitized value: Integer value used by the field panel to determine the logical value, state, and condition of logical points.

Domain Name Server (DNS): Common method of assigning computer names in UNIX-based networks. A DNS server maintains a list of host names and IP addresses, allowing computers that query them to find remote computers by specifying host names rather than IP addresses. DNS is a distributed database; therefore, DNS servers can be configured to use a sequence of name servers, based on the domain in the name being looked for.

Dynamic Host Configuration Protocol (DHCP): Protocol used for automatic TCP/IP configuration of nodes across a network. DHCP dynamically assigns addresses to nodes and allows for central administration of addresses.

dynamic point information: Information stored in the point database that may change during system operation and is not part of the data entered when defining points.

E

enclosure: Metal case that houses the field panel components.

English units: The foot-pound-second system of units for weights and measurements.

enhanced alarming: Application that allows floating alarms and alarm segregation.

Ethernet ready: Any device that communicates over Ethernet cabling. For example, both Ethernet ALN and BACnet/IP field panels are Ethernet ready, even though they use different communication protocols.

F

Field Level Network (FLN): A data communications link that passes information between an FLN device and an Automation Level Network (ALN) device. The terminal Equipment Controller (TEC) is an example of an FLN device.

H

HAND-OFF-AUTO (HOA) switches: Manually operated control switches located on the face of HOA-equipped controllers that enable digital output points to be manually placed into HAND (ON), OFF, or AUTO control. Analog outputs can be placed into AUTO or multiple manual control positions.

Host port: A USB Host port provides support for USB modems and line printers.

Human-Machine Interface (HMI) port: Interfaces of various hardware and/or software units allowing the operator to transfer information to a technical system and/or receive information from the same.

I

Instance ID: The identifying number for objects (for example, points) within a BACnet device. Instance IDs can be assigned manually or automatically within the range set for the host device.

Internet Protocol (IP): A connection-less protocol that allows a packet to travel across multiple networks on its way to its destination. IP is the network layer of TCP/IP suite.

Intrinsic Alarming: BACnet alarming that incorporates alarm destinations (via Notification Classes) within a single alarm message.

M

multicast: Destination IP address that represents one or more interfaces. IP datagrams sent to a multicast address will be sent to all hosts participating in this multicast group.

N

notification class: Notification Class supports enable/disable based on the day of week and time of day and the alarm priority for all points associated with it.

P

Plain Old Telephone Service (POTS): Acronym for the standard telephone service that is used in most homes. Communication speed is generally restricted to 52K bps.

point condition: State of a point such as normal, alarm, alarm-by-command, failed, operator disabled, or proofing.

R

Read Only Memory (ROM): Non-volatile, permanent, but field-programmable memory that stores the operating system of the field panel. ROM stays intact even in the event of a power surge, a power loss, or failure of the battery backup.

S

service box: Component that receives the line power and converts it to 24 Vac for the field panel.

T

telnet: Program that runs on top of TCP/IP, it is the Internet standard protocol for remote login.

text-based terminal: Operator terminal that displays and accepts text only.

To-Fault: A BACnet event indicating that the BACnet object (point) has transitioned to the Fault state from some other state for the recipient or device. A BACnet object mayor may not require acknowledgement of this event by a user.

To-Normal: A BACnet event indicating that the BACnet object (point) has transitioned to the Normal state from some other state for the recipient or device. A BACnet object mayor may not require acknowledgement of this event by a user.

To-OffNormal: A BACnet event indicating that the BACnet object (point) has transitioned to the OffNormal state from some other state for the recipient or device. OffNormal states in BACnet are: OffNormal, high-limit, low-limit, and life-safety-alarm. A BACnet object may or may not require acknowledgement of this event by a user.

tombstone: Remnant or memento of a deleted record that is retained for a finite amount of time in a node's replication database. Tombstones are used to keep track of locally deleted records that must be deleted from replication partners during future global data replication sessions.

totalized value: Sum of information (in hours or minutes) about logical points such as run time, total volume, and degree days.

Transmission Control Protocol/Internet Protocol (TCP/IP): Protocol suite developed by the U.S. Department of Defense to link dissimilar computers across different kinds of networks. TCP/IP is the transport protocol employed by the Internet and is commonly used on Ethernet networks.

U

unbundle: Describes the action of entering a point that resides in an equipment controller's database into the field panel's database so that it can be monitored and controlled from the field panel.

Unicast: Destination IP address that represents a single interface to a single system. IP datagrams sent to a unicast address are sent to a single interface on a single IP host.

User Datagram Protocol (UDP): TCP/IP protocol that provides simple datagram services. UDP is a connection-less mode protocol that is layered on top of IP. UDP does not guarantee delivery and is not used for applications that require acknowledgements or re-transmission.

Index

- 1**
10B/100B Ethernet port..... 33
16- and 24-point Compact
 product diagram 23
 status LEDs 23
16-point Compact
 supported point types 26
- 2**
24-point Compact
 supported point types 26
- 3**
36-point Compact
 product diagram 24
 RS-485 A and B ports 33
 status LEDs 24, 25
 supported point types 27
- A**
agency listings 64
alarm management..... 79
applications
 alarm management 79
 customized applications 80
 Daylight Saving Time (DST)..... 79
 loop/loop tuning 79
 trend data collection 79
 user access and privileges 79
Auto Restore of database 29
Automation Level Network (ALN) 18
 10B/100B Ethernet port..... 33
 BACnet MS/TP ALN 20
 BACnet/IP 20
 HMI and Tool ports 32
 simultaneous ALN access 18
Auto-Restore of database 30
- B**
backup batteries 28
 replacing 83
 typical backup time 30
backup battery
 Real Time Clock (RTC) 29
- BACnet MS/TP ALN**
 number of field panels supported 20
BACnet/IP ALN
 number of field panels supported 20
bus connection module 68
Bus interface module (BIM)..... 68
- C**
communication ports
 10B/100B Ethernet 33
 HMI and Tool 32
compact series
 supported point types 26
compatibility
 TCP/IP protocol 14
customized applications 80
- D**
Database Backup to Flash 29, 30
Daylight Saving Time (DST)..... 79
DHCP server 14, 15
DNS node name format 15
Domain Name Server 14
- E**
electrical specifications 62
electrostatic discharge (ESD)..... 83
- F**
Field Level Network (FLN) 21
Flash Read-Only Memory (Flash ROM) 30
- H**
HOA Upgrade Kits 34
 default mapping 38
 LED feedback 37
 specifications 35
 using HOA switches 36
Human-Machine Interface (HMI)/Tool port..... 32
- I**
IP addresses..... 14
 assignment 15
island bus expansion (IBE) module 68

L	
loop/loop tuning	79
M	
Management Level Network (MLN).....	18
memory	
compressed ROM.....	30
Flash Read-Only Memory (ROM).....	30
memory size and battery backup time.....	30
Random Access Memory (RAM).....	32
O	
operator interface	76
P	
power supply module.....	68
Powers Process Control Language (PPCL).....	77
product diagram	
16- and 24-point Compact.....	23
36--point Compact.....	24
R	
Random Access Memory (RAM).....	32
Real Time Clock (RTC).....	29
RS-485	
TC-36 A and B ports.....	33
S	
service information.....	82
electrostatic discharge (ESD).....	83
reinstalling the mounting tabs.....	84
replacing the batteries	83
specifications	
agency listings	64
dimensions	62
electrical	62
electrical disturbance testing	64
HOA Upgrade Kits.....	35
operating environment.....	63
processor, battery, memory.....	62
status LEDs	
16- and 24-point Compact.....	23
36- point Compact	24, 25
T	
TCP/IP protocol	
address assignment	15
compatibility.....	14
default TCP/IP port number.....	15
default UDP port number.....	15
device registration	14
DNS node name format.....	15
network bandwidth	15
network security.....	15
required IP addresses	14
trend data collection.....	79
troubleshooting	
24 Vac LED	86
BATT LOW LED	84, 85
communication issues	85
I/O module status LED	86
RUN LED.....	85
TX-I/O product range	64
TX-I/O Product Range	
power and bus modules	68
TX-I/O island bus.....	34
U	
UDP port number.....	15
USB Device port.....	33
USB Host port.....	33
user access and privileges.....	79
user accounts	79

Issued by
Siemens Industry, Inc.
Building Technologies Division
1000 Deerfield Pkwy
Buffalo Grove IL 60089
+1 847-215-1000

© Siemens Industry, Inc., 2019
Technical specifications and availability subject to change without notice.